

SURGICAL INSTRUMENTS

Trust On Quality
And Service

Diagnostic
Laryngoscope
Scissors
Dissecting
Hamostats Forceps
Needle Holders
Retractors
Cordio Vascular
Electro Surgical
Hollow Ware



Manufacturer & Exporters Of
Surgical Instruments

 :82 Hatherley Road Reading,
England Rg1 5qe

 :0047808584900

 :info@aisons.co.uk

 :www.aisons.co.uk

We present this CATALOGUE with a hope that it would be an excellent guide to all over promoters and Surgical professionals the world over.

We endeavor to present in this CATALOGUE a modern range of instruments to the trade and medical professionals in order to achieve the highest result.

We are the located in the center of the city which is known the world over for this profession having at our disposal expert crafted whose skilled technique and traditional approach towards modern surgery makes all the possibilities to acclaim us quality instruments producers.

We are grateful for the loyal support given to us by our promoters who have been selling our Stainless Steel Surgical Instruments in their market with pride and honor.

We pledge to serve more in the years ahead to our quality minded promoters with much more higher standard and correct design of the instruments.

We also welcome our enquiries for the instruments not listed in This CATALOGUE both in Surgical instruments.

It is our earnest desire to maintain our present price but due to the present universal economic condition which are beyond our control, all prices are subjected to change without any notice.



**DIAGNOSTIC SET
(ENT COMPLETE)
101-0001**
Consisting of Battery Handle (without Battery)
3 Ear Specula, 1 Nasel Specula,
2 Laryngeal mirrors with Holder
1 Tongue Depressor Holder, 1 Bulb



**OTOSCOPE Set
101-0002**
Consisting of Battery Handle
(without Battery) 3 Ear Specula, 1 Bulb

● ● ● Diagnostic

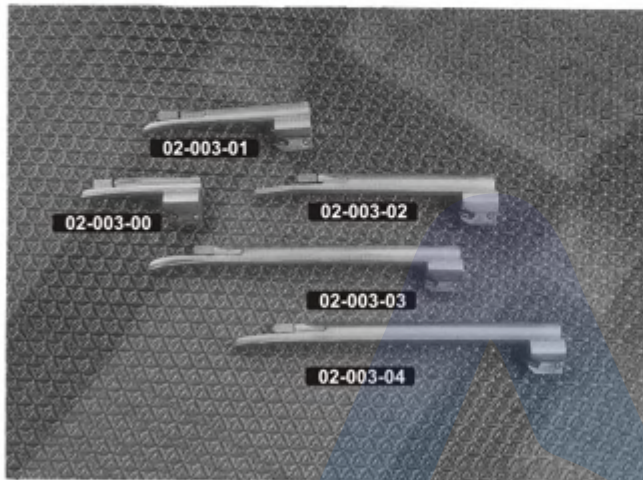

Miller



Miller
101-0003
Laryngoscope
set



**DIAGNOSTIC SET
(ENT COMPLETE)
101-0001**
Consisting of Battery Handle (without Battery)
3 Ear Specula, 1 Nasel Specula,
2 Laryngeal mirrors with Holder
1 Tongue Depressor Holder, 1 Bulb



**OTOSCOPE Set
101-0002**
Consisting of Battery Handle
(without Battery) 3 Ear Specula, 1 Bulb

●●● Surgical Handles



No.3L
102-0001

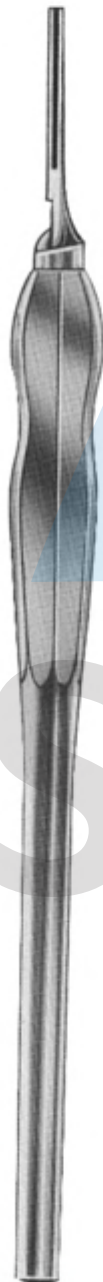

ERGONOMIC
102-0002



No.7
102-0003

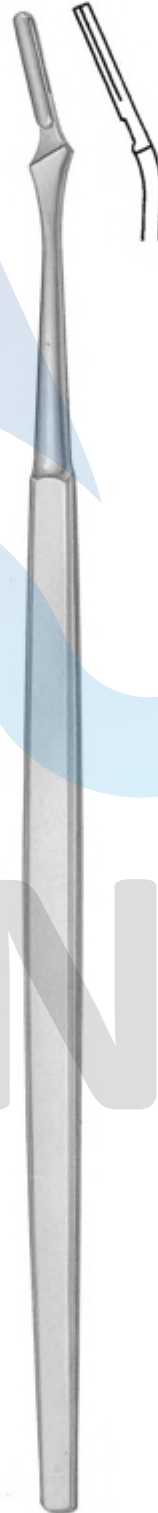

102-0004



102-0005



102-0006



No.4L
102-0007



No.4
102-0008

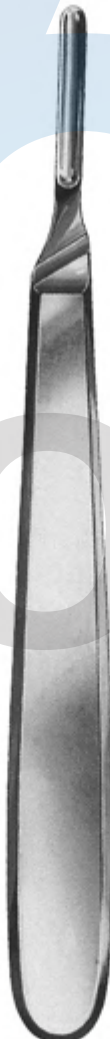

No.10
102-0009



No.9
102-0010



No. 3
102-0011



BARRON
102-0012
For "B.P." type blades
for use with No's
10,11,12 & 15 blades
135mm (5.1/4")

● ● ● Scissors

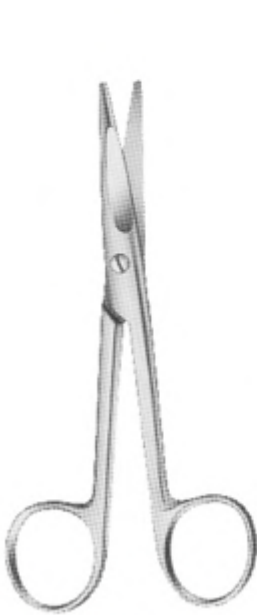

MAYO
Straight, bevelled blades



103-0001
140 mm
(5.1/2")

103-0002
170 mm
(6.3/4")

103-0003
190 mm
(7.1/2")

103-0004
215mm
(8.1/2")



103-0005
140 mm
(5.1/2")

103-0006
170 mm
(6.3/4")

103-0007
190 mm
(7.1/2")

103-0008
215mm
(8.1/2")

Curved on flat, bevelled blades

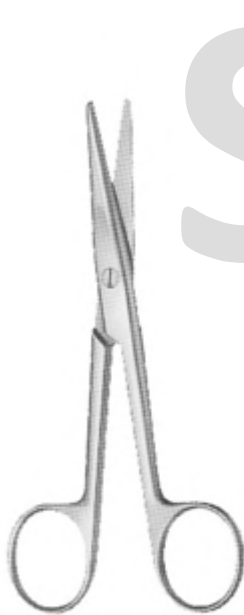

MAYO
Round Blades



103-0009
170 mm
(6.3/4")

103-0010
140mm
(5.1/2")

200mm
(8")
Straight

150 mm
(6")
Straight



MAYO
Round Blades



103-0011
170 mm
(6.3/4")

103-0012
140mm
(5.1/2")

200mm
(8")
Curved on
flat

150 mm
(6")
Curved on
flat

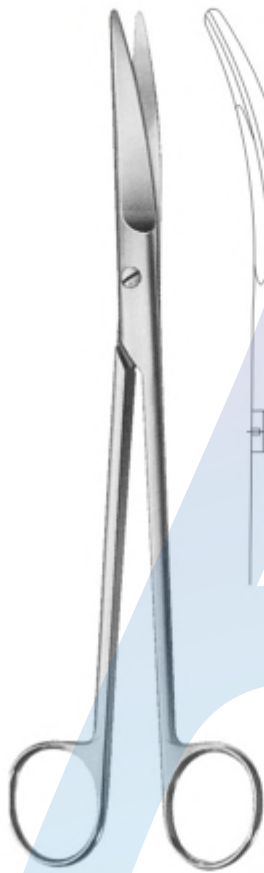

MAYO HARRINGTON
103-0013
225mm (9")
Curved on flat , blunt points

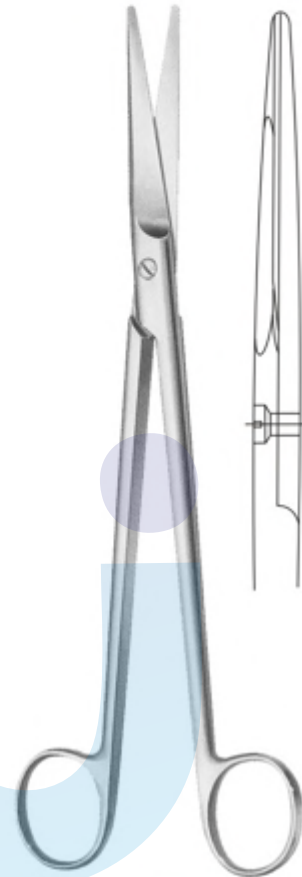

MAYO HARRINGTON
103-0014
225mm (9")
Straight, blunt points



MAYO (STILLE)



103-0015
170 mm
(6.3/4")
Straight



103-0016
150 mm
(6")
Straight



103-0017
170 mm
(6.3/4")
Curved on
flate



103-0018
150 mm
(6")
Curved on
flate



● ● ● Scissors



METZENBAUM

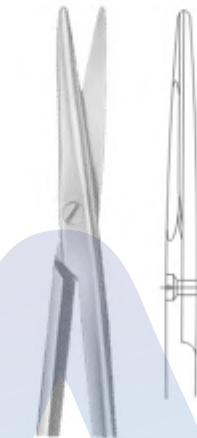

METZENBAUM
 Straight, blunt points
103-0019 115mm (4.1/2")
103-0020 145mm (5.3/4")
103-0021 180mm (7")
103-0022 200mm (8")

METZENBAUM (Nelson)
 Straight
103-0023 230mm (9")
103-0024 250mm (10")



METZENBAUM
 Curved on flat, blunt points
103-0025 115mm (4.1/2")
103-0026 145mm (5.3/4")
103-0027 180mm (7")
103-0028 200mm (8")

METZENBAUM (Nelson)
 Curved on flat
103-0029 230mm (9")
103-0030 250mm (10")



DRESSING
 Straight, blunt / blunt points
103-0031 125mm (5")
103-0032 145mm (5.3/4")
103-0033 150mm (6")
103-0034 180mm (7")
103-0035 200mm (8")

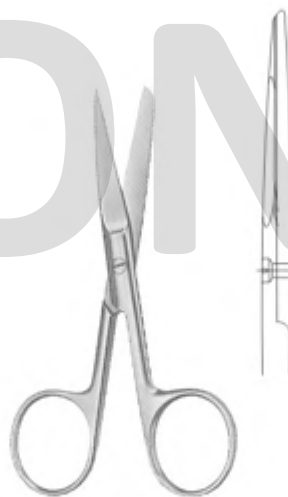

DRESSING
 Straight, sharp / blunt points
103-0036 125mm (5")
103-0037 145mm (5.3/4")
103-0038 150mm (6")
103-0039 180mm (7")
103-0040 200mm (8")



DRESSING
 Straight, sharp / Sharp points
103-0041 125mm (5")
103-0042 145mm (5.3/4")
103-0043 150mm (6")
103-0044 180mm (7")
103-0045 200mm (8")



CRAFOORD
103-0046 305mm (12")
Straight

LLOYD DAVIS RECTAL
blunt points, flat blades
103-0047 255mm (10")
Curved on flat
103-0048 255mm (10")
Straight

UTERINE
103-0049 230mm (9")
Straight, blunt points

UTERINE
Curved on flat, blunt points
103-0050 200mm (8")
103-0051 230mm (9")

● ● ● Scissors



**BRAUN STADTLER
EPISIOTOMY** Angled blades
103-0052 145mm (5.3/4")
103-0053 200mm (8")



**AMERICAN PATTERN
UMBILICAL** Angled blades
103-0054 100mm (4")



HEGEMANN'S DELICATE
190mm (7.1/2")

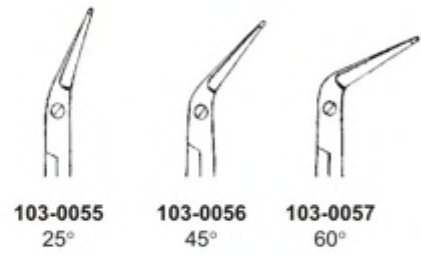

103-0055
25°

103-0056
45°

103-0057
60°

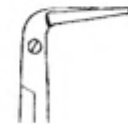

103-0058
90°



103-0059
120°

SONS



KILNER
103-0060 110mm (4.1/2")
Straight, sharp points
103-0061 110mm (4.1/2")
Curved on flat, blunt points

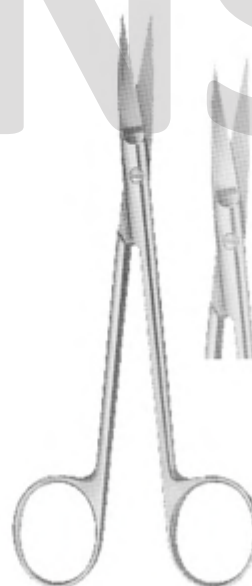
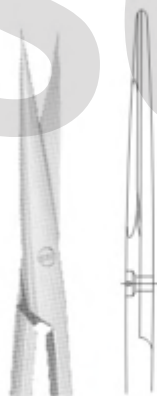

AUFRICHT
150mm (6") Lightweight
103-0062 Straight
103-0063 Curved on flat

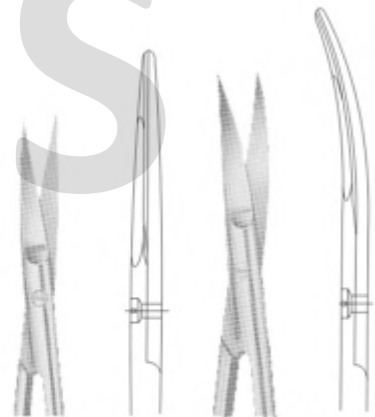



IRIS
110mm (4.1/2")
sharp points



103-0064
Straight
103-0065
Curved on flat



IRIS
110mm (4.1/2")
Round blades,
sharp points



103-0066
Straight
103-0067
Curved on flat



IRIS
103-0068 90mm (3.1/2")
Curved on flat, lightweight
sharp points



STRABISMUS

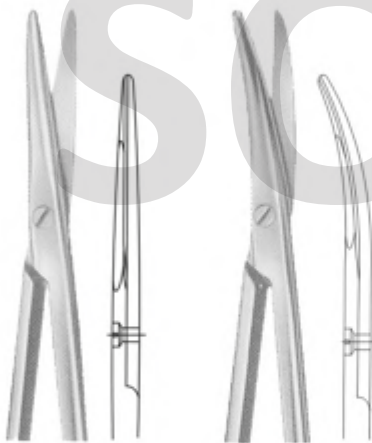

103-0069 110mm (4.1/2")
Straight
103-0070 110mm (4.1/2")
Curved on flat



HEYMANN
TURBINECTOMY
103-0071 185mm (7.1/4")
Angled shanks
blunt points

●●● Delicate & Oral Scissors



STEVENS TENOTOMY
110 mm (4.1/4")

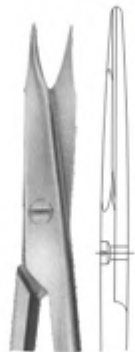

103-0072
straight,
sharp points

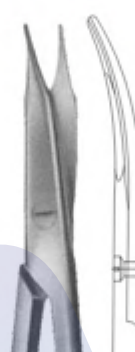

103-0073
Curved on flat
sharp points



103-0074
straight,
blunt points



103-0075
Curved on flat
blunt points

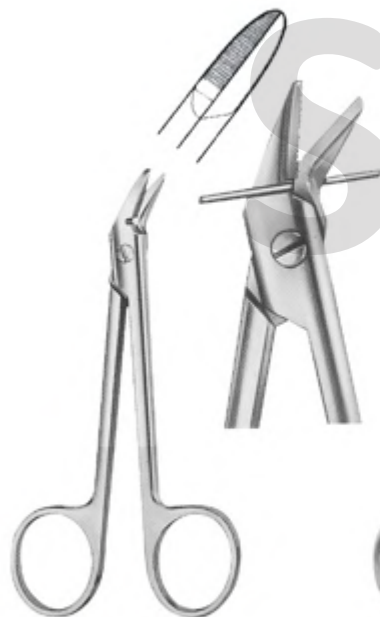

**SCHUKNECHT
WIRE CUTTING**
103-0076 125mm (5")



WOODS TONSIL
190mm (7.1/2")



103-0077
Curved on flat
sharpened
outer edge, blunt



WHEELER TONSIL
103-0078 200mm (8")
Curved on flat

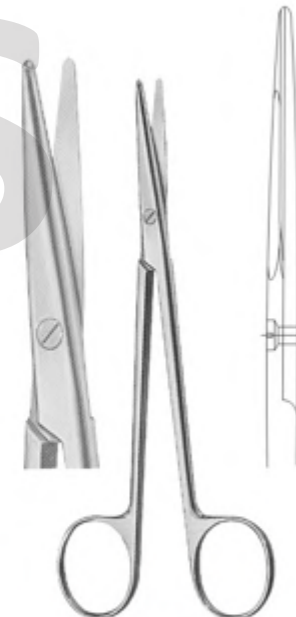

WILSON TONSIL
103-0079 180mm (7")
Straight

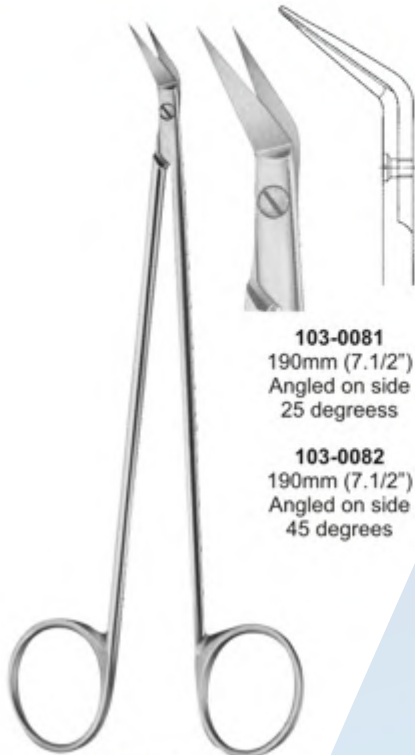

103-0081
190mm (7.1/2")
Angled on side
25 degrees

103-0082
190mm (7.1/2")
Angled on side
45 degrees

POTTS
103-0080 190mm (7.1/2")
Angled on flat 45 degrees

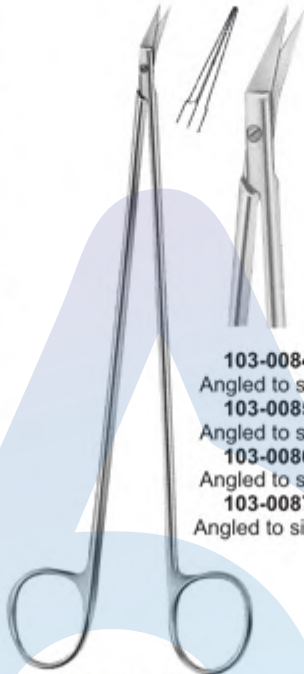

103-0084 175mm (7")
Angled to side, 45 degrees
103-0085 175mm (7")
Angled to side, 60 degrees
103-0086 175mm (7")
Angled to side, 90 degrees
103-0087 175mm (7")
Angled to side, 125 degrees

HEDGEMAN (DIETRICH)
103-0083 175mm (7")
Angled to side, 25 degrees

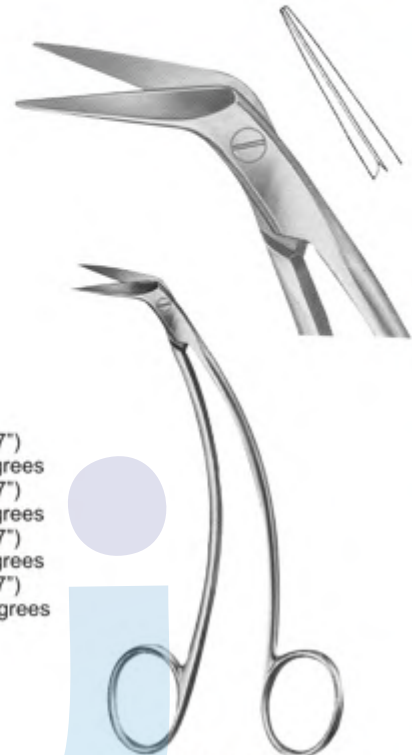

FAVALORO
103-0088 150mm (6")
Shanks curved, blades angled to side

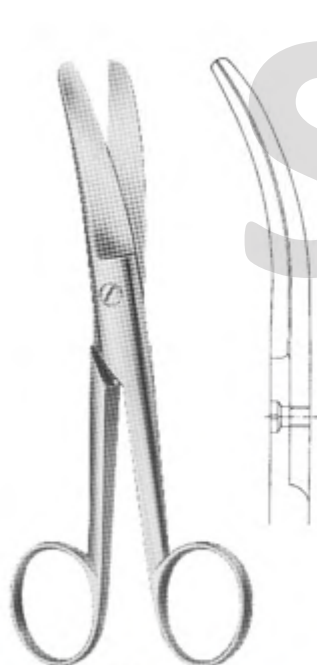

DOYEN ABDOMINAL
103-0089 180mm (7")
Curved, blunt points

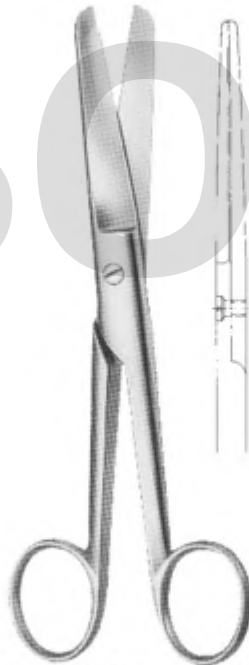

DOYEN ABDOMINAL
103-0090 180mm (7")
Straight, blunt points

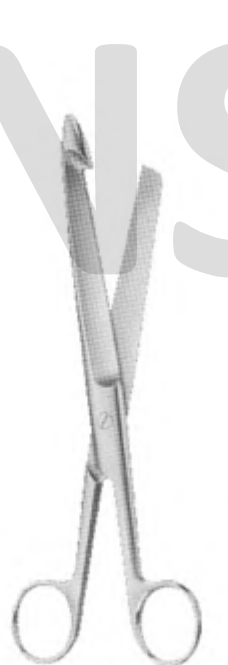

DOYEN ABDOMINAL
103-0091 210mm (8.1/4")
One blade with hook end



COUNTER SCISSORS
103-0092 210mm (8.1/4")

● ● ● Scissors

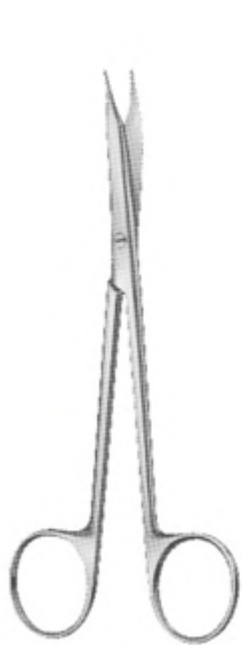

REYNOLDS
Curved on flat, tapered points

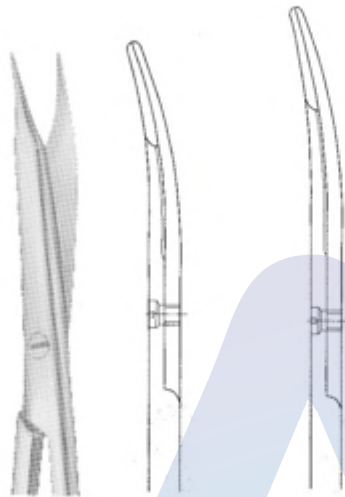

103-0093 145mm (5.3/4")
103-0094 180mm (7")

103-0095 115mm (4.1/2")
103-0096 140mm (5.1/2")
103-0097 180mm (7")
103-0098 200mm (8")
103-0099 235mm (9.1/4")

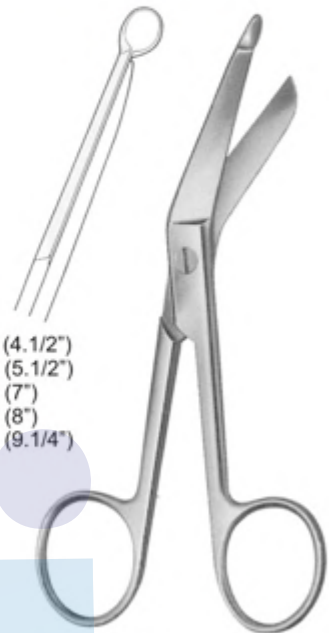

LISTER BANDAGEz



SCHUMACHER UMBILICAL
103-0100 155mm (6")



MCINDOE SCISSORS
103-0101 180mm (7")
Straight

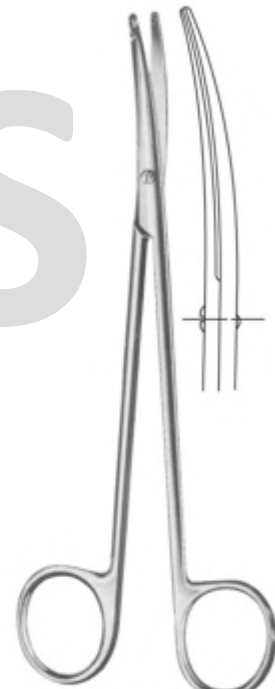

MCINDOE SCISSORS
103-0102 180mm (7")
Curved

Serrated Dissecting Forceps ●●●



CANADIAN
Straight
104-0001 130mm (5.1/8")
104-0002 150mm (6")



DISSECTING FORCEPS
Turn over end
104-0003 125mm (5")
104-0004 150mm (6")
104-0005 180mm (7")
104-0006 200mm (8")
104-0007 250mm (10")



DISSECTING FORCEPS
Block end
104-0008 125mm (5")
104-0009 150mm (6")
104-0010 180mm (7")
104-0011 200mm (8")
104-0012 250mm (10")



DISSECTING FORCEPS 104-0013
150mm (6")



104-0014
180mm (7")



104-0015
200mm (8")

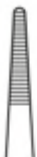

104-0016
115mm (4.1/2")



104-0017
130mm (5.1/8")



104-0021
115mm (4.1/2")



104-0022
130mm (5.1/8")



104-0023
150mm (6")



104-0024
160mm (6.1/4")



DISSECTING FORCEPS



104-0018
145mm (5.3/4")



104-0019
160mm (6.1/4")



104-0020
305mm (12")



DISSECTING FORCEPS
Round Points



104-0025
180mm (7")



104-0026
200mm (8")

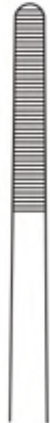

104-0027
250mm (10")



104-0028
300mm (12")

●●● Serrated Dissecting Forceps

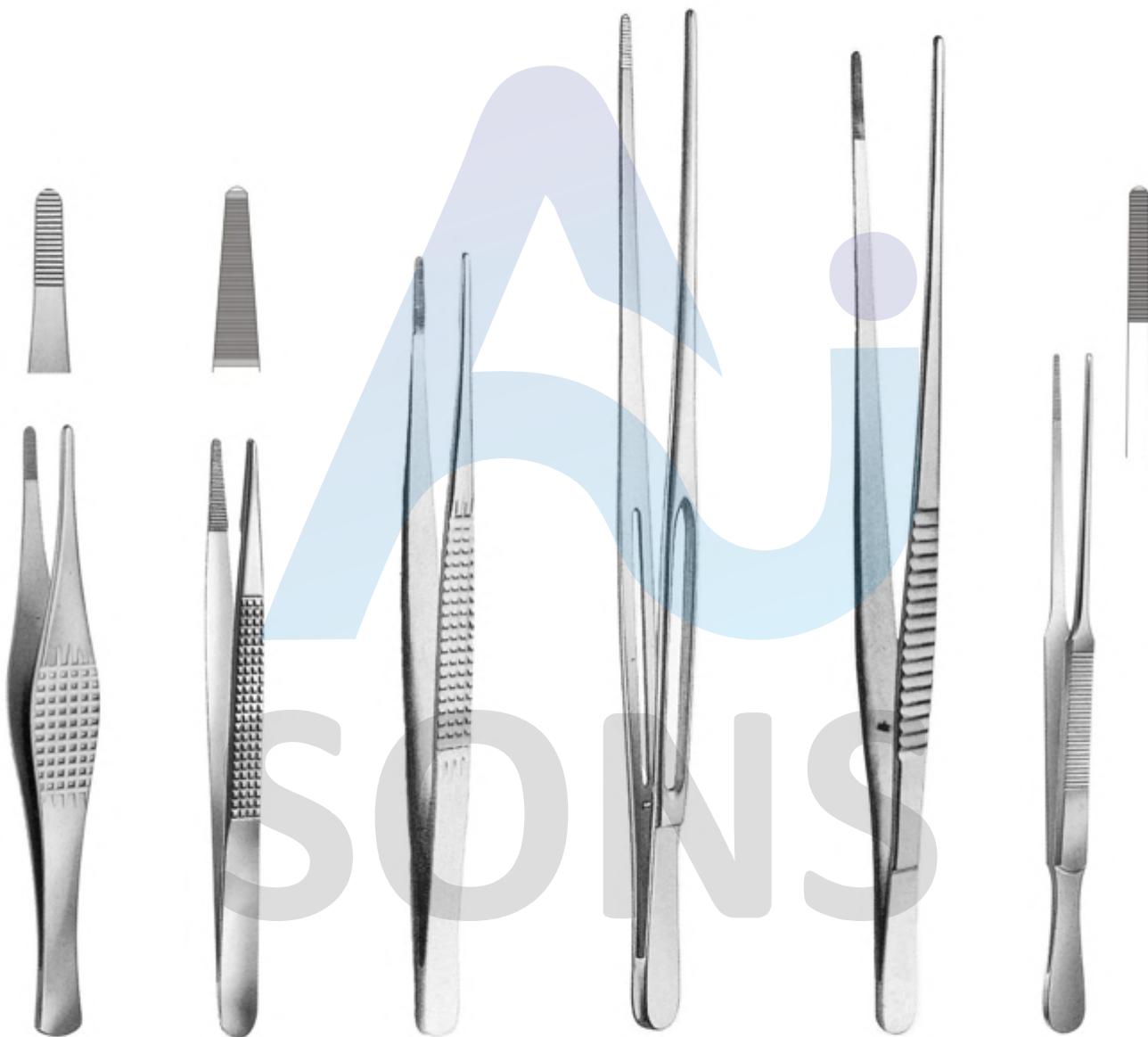

RAMSEY
104-0029
180mm (7")

BONNEY
104-0030
180mm (7")

BICKFORD
104-0031
225mm (9")

MAINGOT INTESTINAL
Fenestrated Grip
104-0032
280mm (11")

ST MARKS
104-0033
290mm (11.1/2")

EMMET
104-0034
200mm (8")

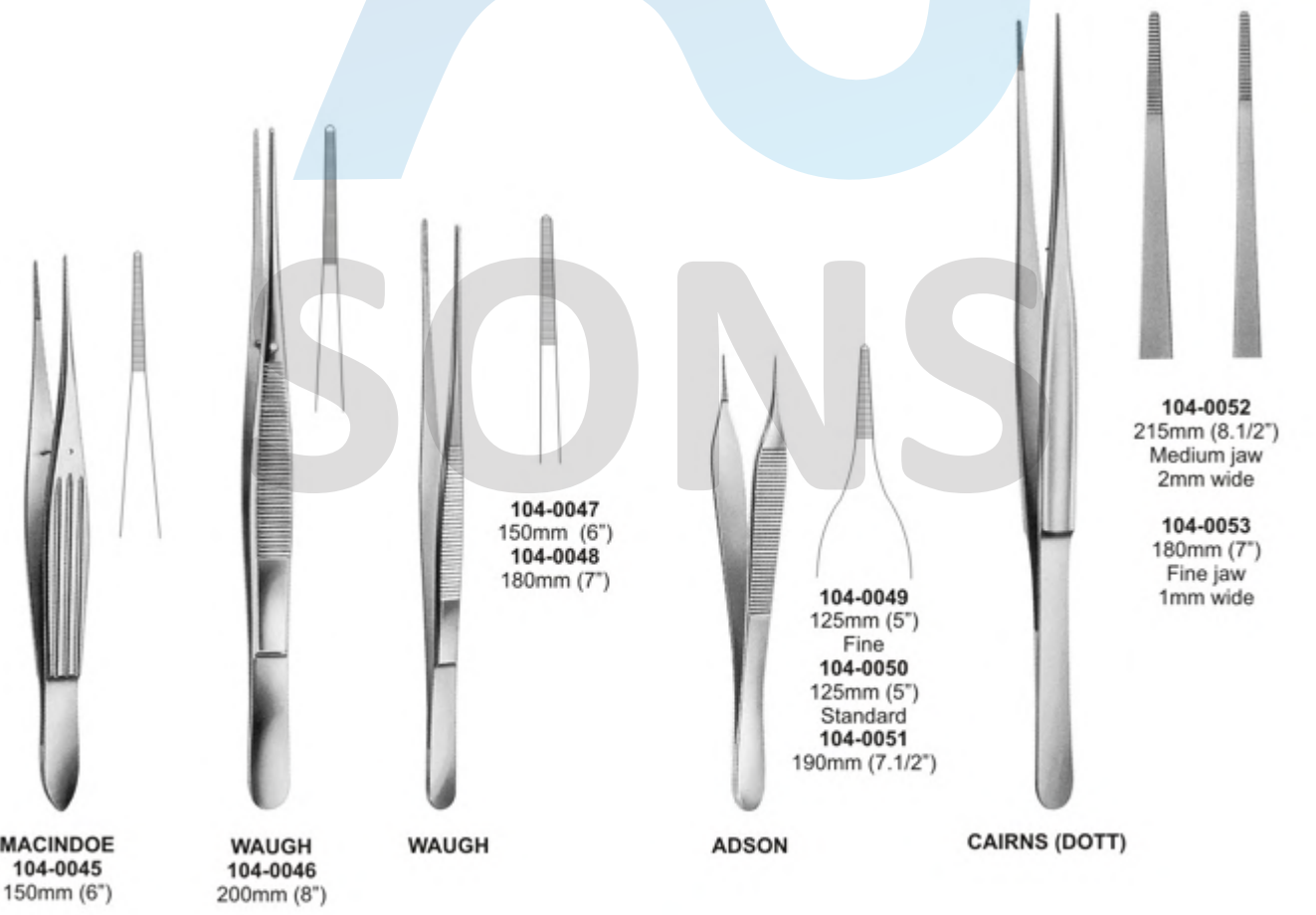
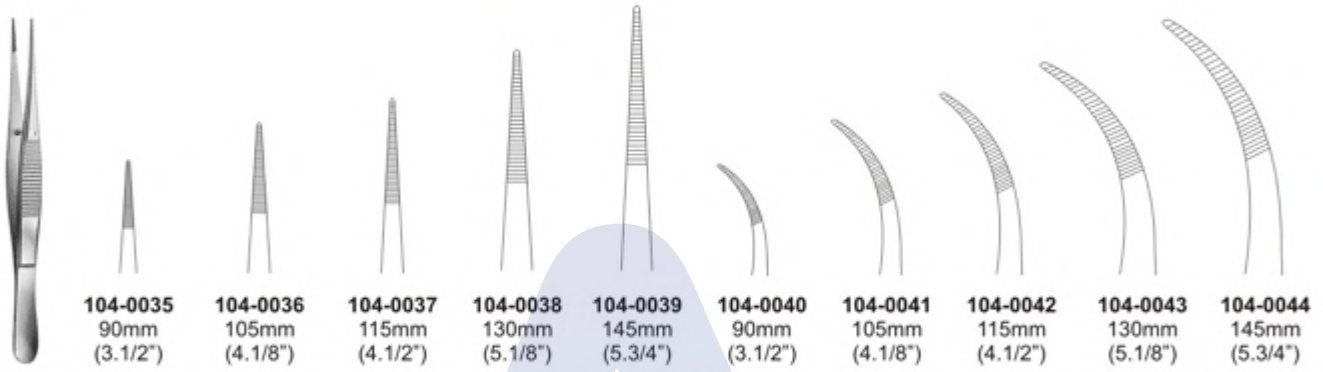

●●● Delicate Dissecting Forceps



TREVES
1 x 2 teeth

- 104-0054
125mm (5")
- 104-0055
150mm (6")
- 104-0056
180mm (7")
- 104-0057
200mm (8")
- 104-0058
250mm (10")



LANE
1 x 2 teeth

- 104-0059
125 mm (5")
- 104-0060
145mm (5.3/4")
- 104-0061
180mm (7")
- LANE**
2 x 3 teeth
- 104-0062
145mm (5.3/4")
- 104-0063
180mm (7")



DISSECTING FORCEPS

- 104-0064
150mm (6")
2 x 3 teeth
- 104-0065
150mm (6")
3 x 4 teeth



WAUGH
1 x 2 teeth



- 104-0066
200mm (8")
- 104-0067
180mm (7")
- 104-0068
150mm (6")



ADSON
1 X 2 teeth

- 104-0069
125mm (5") Fine
- 104-0070
125mm (5") Standard
- 104-0071
190mm (7.1/2")



ADSON
Bayonet
1 x 2 teeth

- 104-0072
190mm (7.1/2")



JEFFERSON
1 x 2 teeth



- 104-0073
180mm (7")



ADSON-BROWN
7 x 7 teeth



- 104-0074
125mm (5")



PENNYBACKER
3 x 4 teeth
104-0075
160mm (6.1/2")

Toothed Dissecting Forceps ●●●

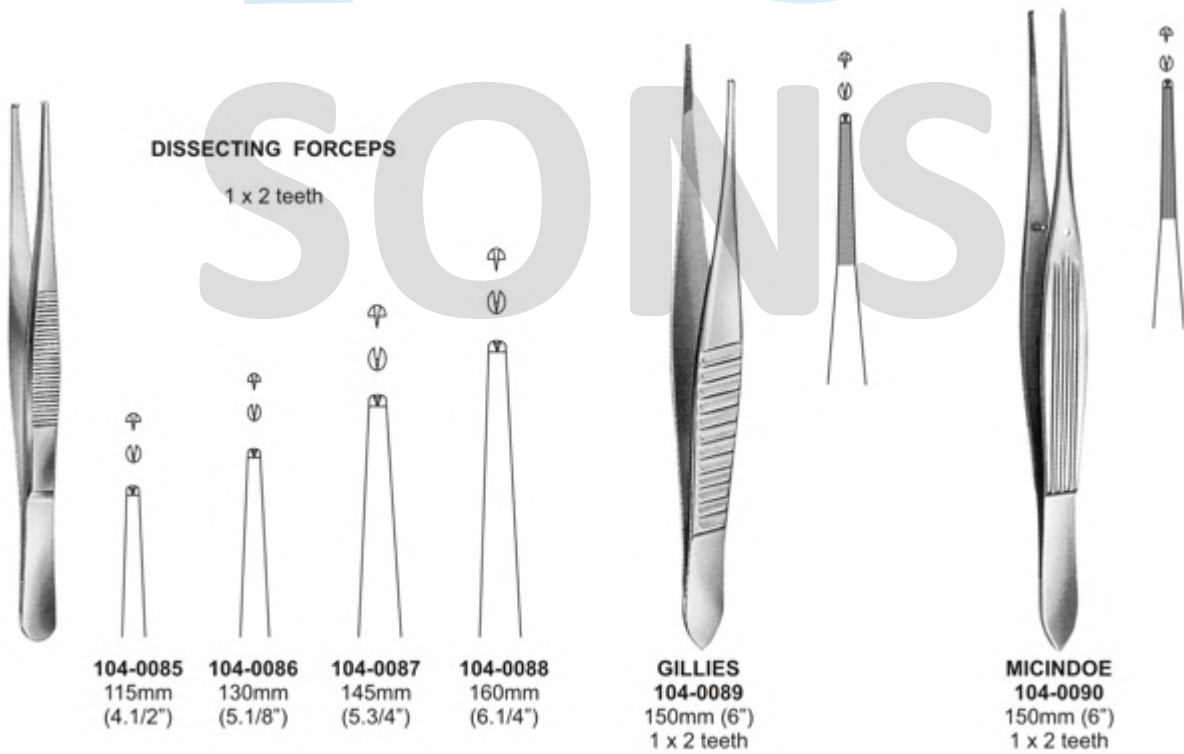
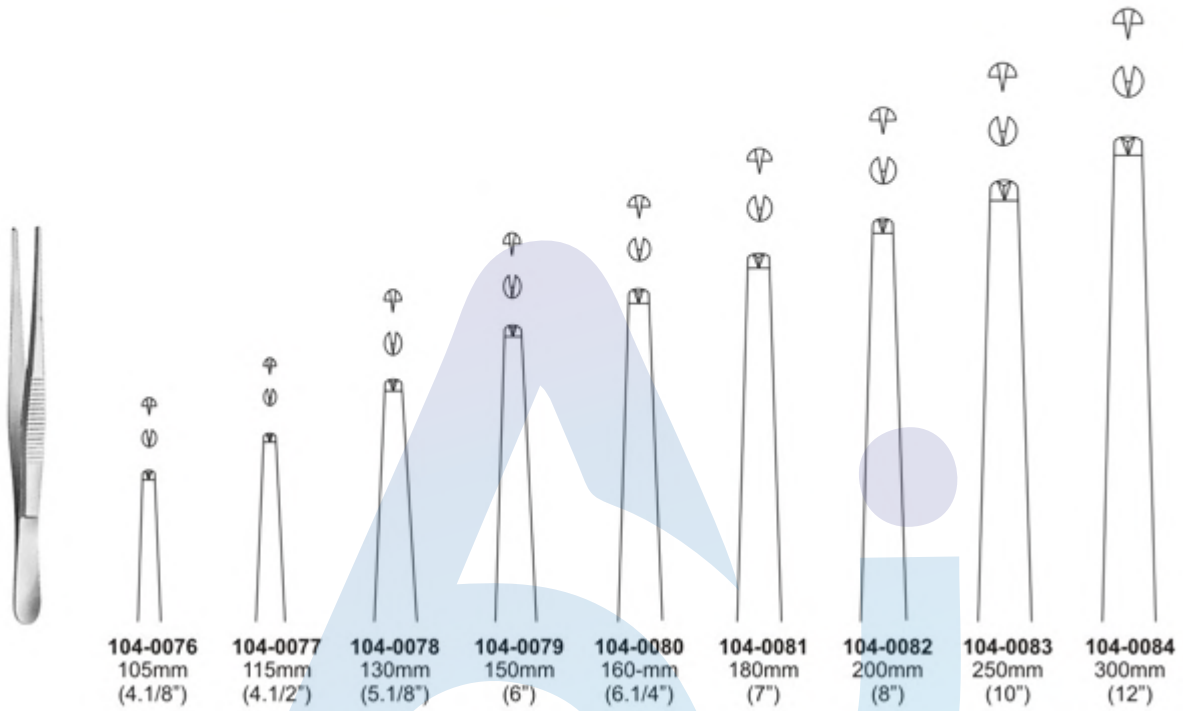

●●● Toothed Dissecting Forceps



104-0091
SILCOCK
1 x 2 teeth

104-0092
100mm (4")
104-0093
110mm (4.3/8")



104-0094



104-0095
FINE
1 x 2 teeth
104-0096
100mm (4")
104-0097
100mm (4")



104-0098



104-0099



104-0100



RAMSEY
180mm (7")



BONNEY
1 x 2 teeth

104-0101
180mm (7")



BICKFORD
1 x 2 teeth

104-0102
225mm (9")



CANADIAN
2 x 3 teeth

104-0103
140mm (5.1/2")

104-0104
150mm (6")

Toothed Dissecting Forceps ●●●

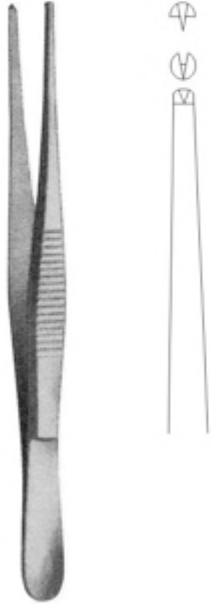

ST MARKS
1 X 2 teeth
104-0105
290mm (11.1/2")



OFFICER
4 x 5 teeth
104-0106
150mm (6")



JACKSON BURROWS
1 x 2 teeth
104-0107
140mm (5.1/2")



MUSTARDE
Combined, double hooked jaw
104-0108
150mm (6")



RUSSIAN
With circular jaw
104-0109
150mm (6")
104-0110
200mm (8")
104-0111
250mm (10")



NELSON LUNG ADHESION
104-0112
230mm (9")



●●● Splinter Forceps



**104-0113
ARTHURE**
140mm (5.1/2")

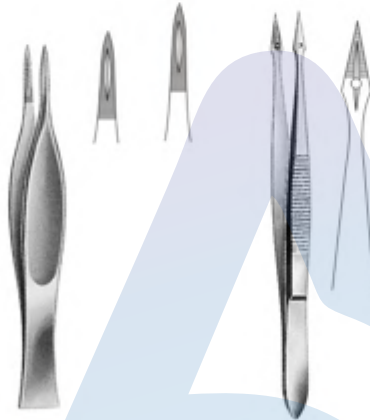

**104-0114
FEILCHENFEL**
70mm (3")
90mm (3.1/2")
115mm (4.1/2")



**104-0115
HUNTER**
105mm (4.1/8")



**DENIS BROWNE
104-0116**
190mm (7.1/2")



MICRO SOFT TOUCH RING TIP
104-0117
150mm (6")
104-0118
185mm (7.1/4")
104-0119
210mm (8.1/4")
104-0120
230mm (9")
104-0121
250mm (10")



TROELTSCH (Wilde)
104-0122
110mm (4.1/2")



TROELTSCH (Wilde)
104-0123
120mm (4.3/4")
1 x 2 teeth



TUDICHUM
104-0124
65mm (2.3.1/2")

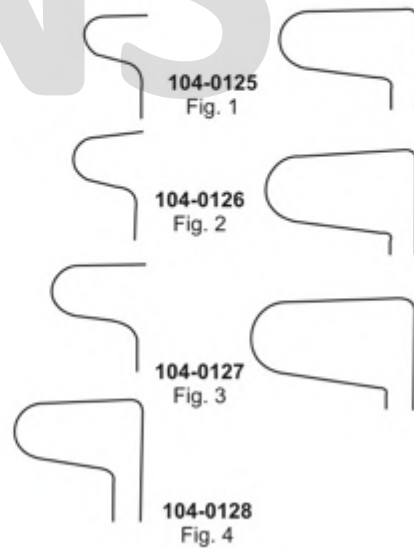

104-0125
Fig. 1

104-0126
Fig. 2

104-0127
Fig. 3

104-0128
Fig. 4

Dissecting & Ligature Forceps ●●●



LIGATURE FORCEPS
105-0001
95mm (3.3/4")
Straight, smooth jaw



MICRO ADSON
105-0002
140mm (5.1/2")

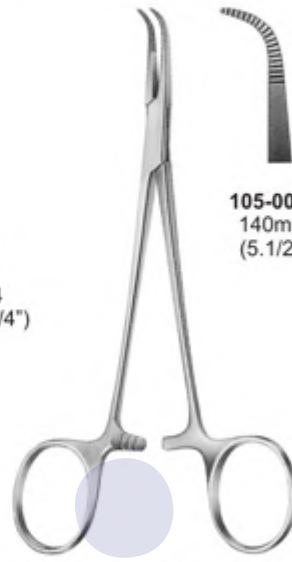

BABY - ADSON

105-0005
140mm
(5.1/2")

105-0006
180mm
(7")

105-0003
185mm (7.1/4")

105-0004
210mm (8.1/4")

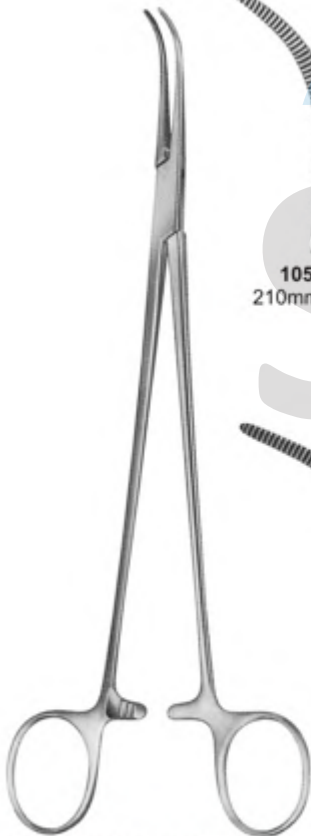

FINE CURVED DISSECTING FORCEPS



105-0007
210mm (8.1/4")



105-0008
215mm (8.1/2")



105-0009
220mm (8.3/4")



105-0010
225mm (9")



105-0011
225mm (9")



105-0012
295mm (11.3/4")



105-0013
295mm (11.3/4")



105-0014
300mm (12")



S.SHAPED DELICATE

●●● Dissecting & Ligature Forceps

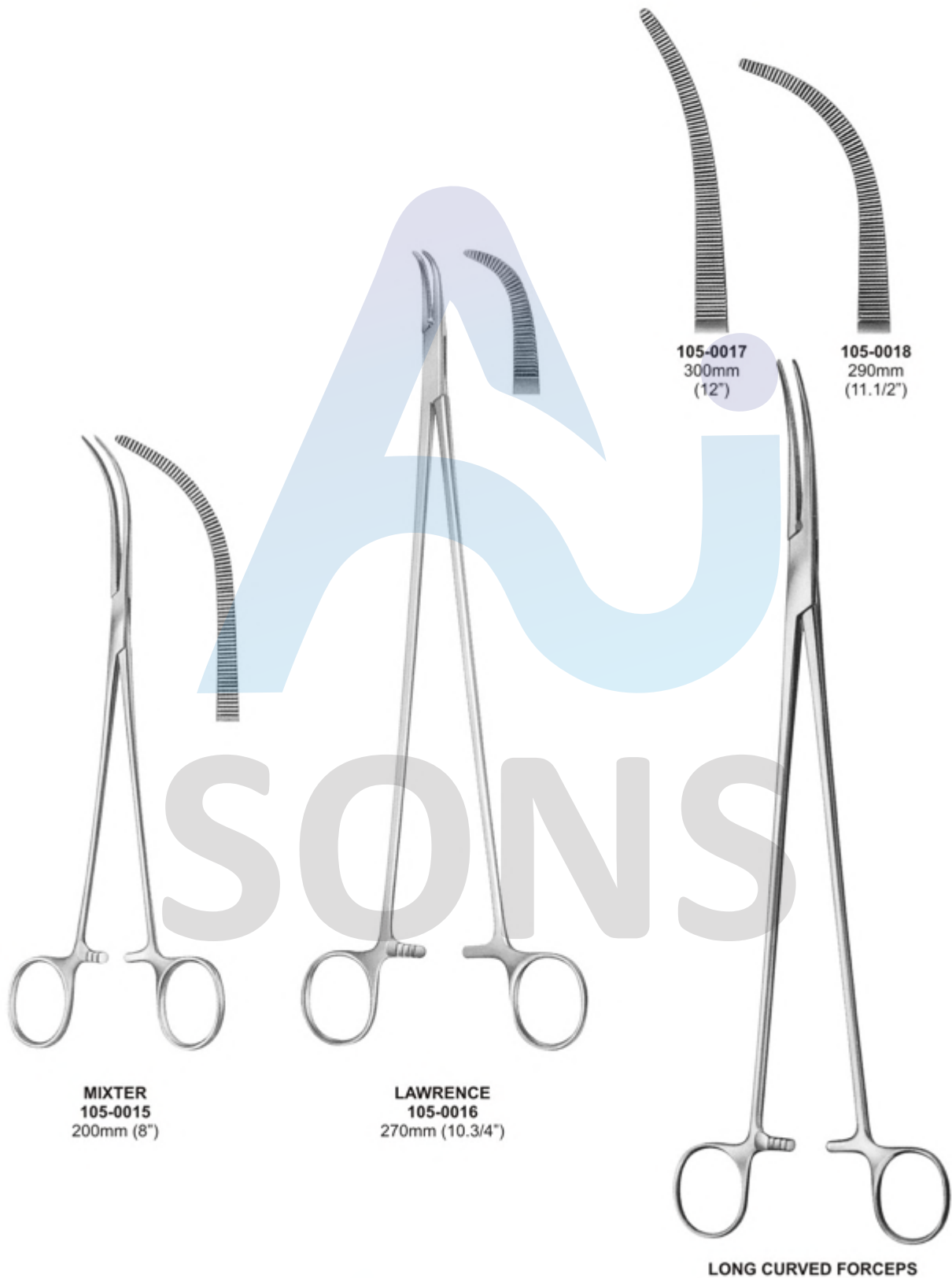



RUTHERFORD MORISON
105-0019 150mm (6")
6 x 7 teeth

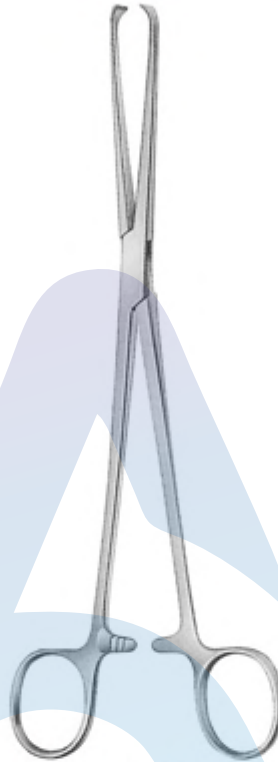

STILES (ALLIS-THOMS)
105-0020 200mm (8")
6 x 7 teeth

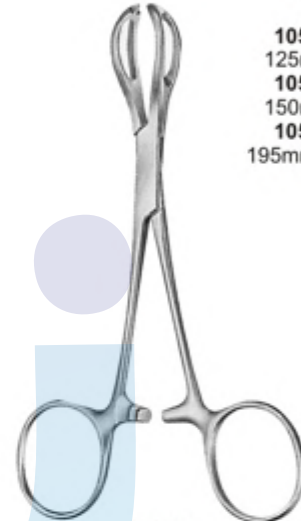

LANE
1 x 2 teeth fenestrated



- 105-0021 125mm (5")
- 105-0022 150mm (6")
- 105-0023 195mm (7.3/4")



BABCOCK
105-0024 165mm (6.1/2")

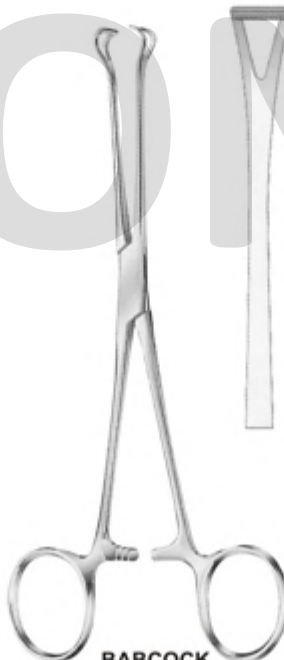

BABCOCK
105-0025 200mm (8")
Extra light



BABCOCK
105-0026 230mm (9")

●●● Tissue Forceps



ALLIS
150mm (6")
105-0027 2 x 3 teeth
105-0028 3 x 4 teeth
105-0029 4 x 5 teeth
105-0030 5 x 6 teeth
105-0031 6 x 7 teeth

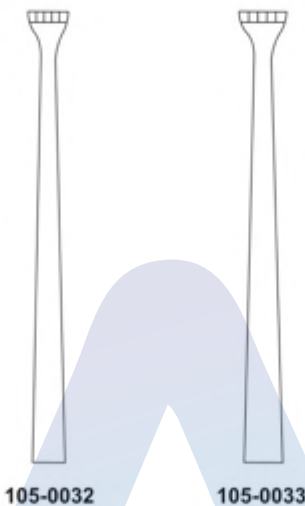

105-0032

105-0033



AMERICAN PATTERN ALLIS
105-0034 150mm (6") 3 x 4 teeth

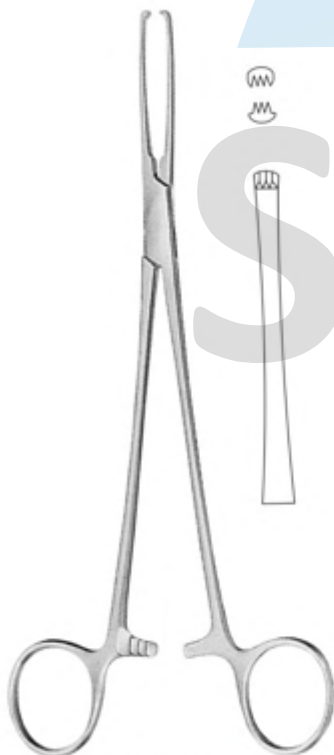

JUD-ALLIS
105-0035 195mm (7.3/4")
Light pattern, 3 x 4 teeth



CHAPUT (POIRIER)
105-0036 125mm (5") 2 x 3 teeth



ALLIS
105-0037 190mm (7.1/2")
105-0038 255mm (10") 5 x 6 Teeth

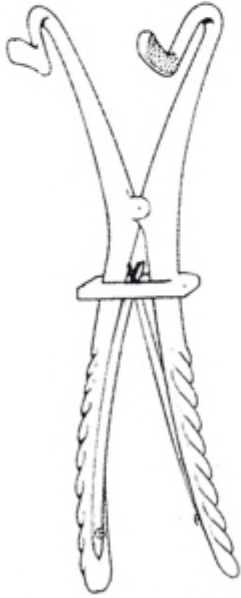

FERGUSSON ACLAND

105-0039
170mm (6.3/4")

105-0040
200mm (8")



DOYEN (CHILD)

105-0041
120mm (4.3/4")

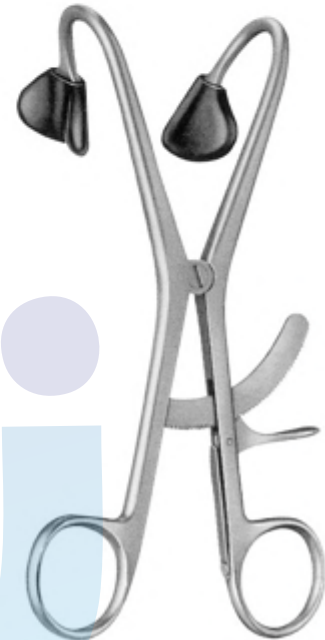

FEATHERSTONE

105-0042
165mm (6.1/2")



DOYEN (ADULT)

105-0043
140mm (5.1/2")

SONS

●●● Tongue Depressors



105-0044
180mm (7")

FLAT TONGUE DEPRESSOR
Double ended
tapering 19mm + 23mm



105-0045
140mm (5.1/2")

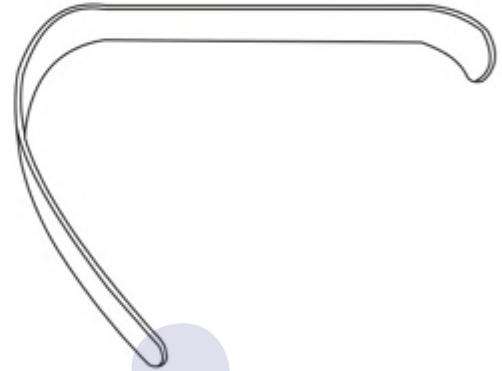

LACK TONGUE DEPRESSOR
105-0046 13mm wide
child
105-0047 19mm wide
Adolescent
105-0048 22mm wide
Adults

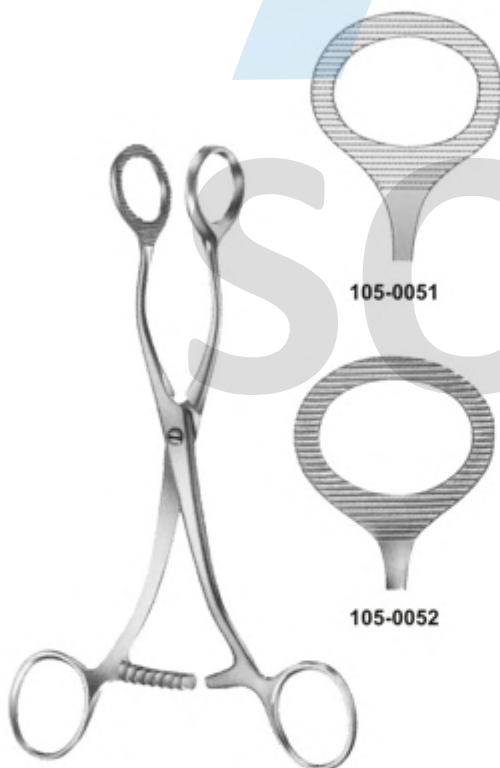

COLLIN TONGUE FORCEPS
105-0049 170mm (6.3/4")
105-0050 160mm (6.1/4")



105-0051

105-0052

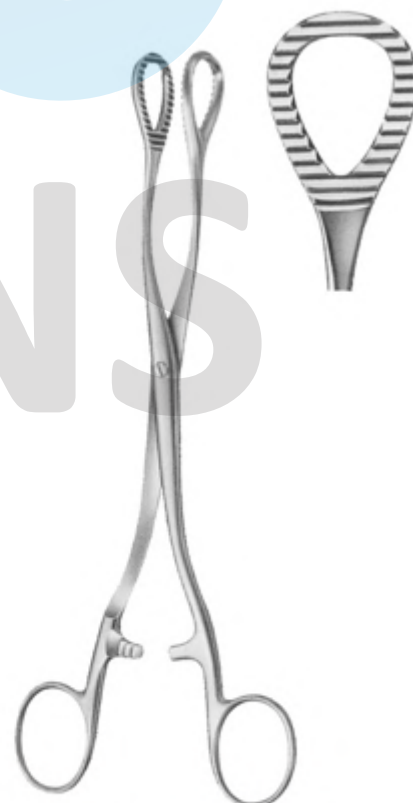

HEYWOOD-SMITH TONGUE FORCEPS
105-0053 200mm (8")



ROBIN

105-0054 140mm (5.1/2")
holder diameter 5mm
105-0055 140mm (5.1/2")
holder diameter 13mm
105-0056 140mm (5.1/2")
holder diameter 25mm



EDNA (LORNA)
105-0057
100mm (4")



EDNA (LORNA)
105-0058
130mm (5.1/4")

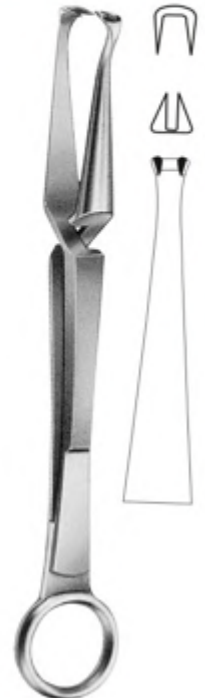

DOYEN
105-0059
190mm (7.1/2")



BALL AND SOCKET
105-0062 130mm (5")

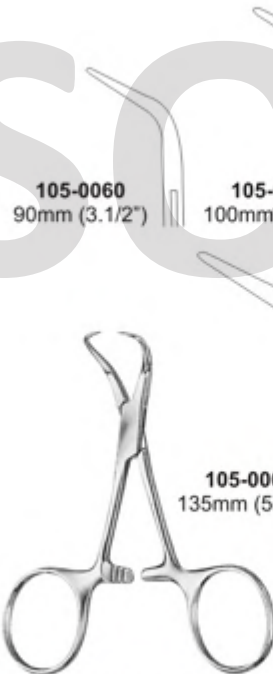

BACKHAUS

105-0063
135mm (5.1/4")



MAYO
105-0064 140mm (5.1/2")



MOYNIHAN
105-0065
190mm (7.1/2") 2 x 2 teeth

SONS

105-0060
90mm (3.1/2")

105-0061
100mm (4.3/4")

●●● Sponge Holding Forceps



RAMPLEY

105-0066
180mm (7")

105-0067
240mm (9.1/2")



FORESTER

105-0068
240mm (9.1/2")

105-0069
180mm (7")
Straight

105-0070
240mm (9.1/2")

105-0071
180mm (7")
Curved on flat



105-0072



105-0073

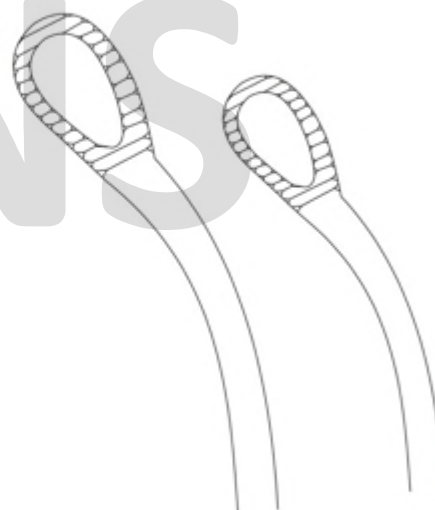

105-0074

105-0075

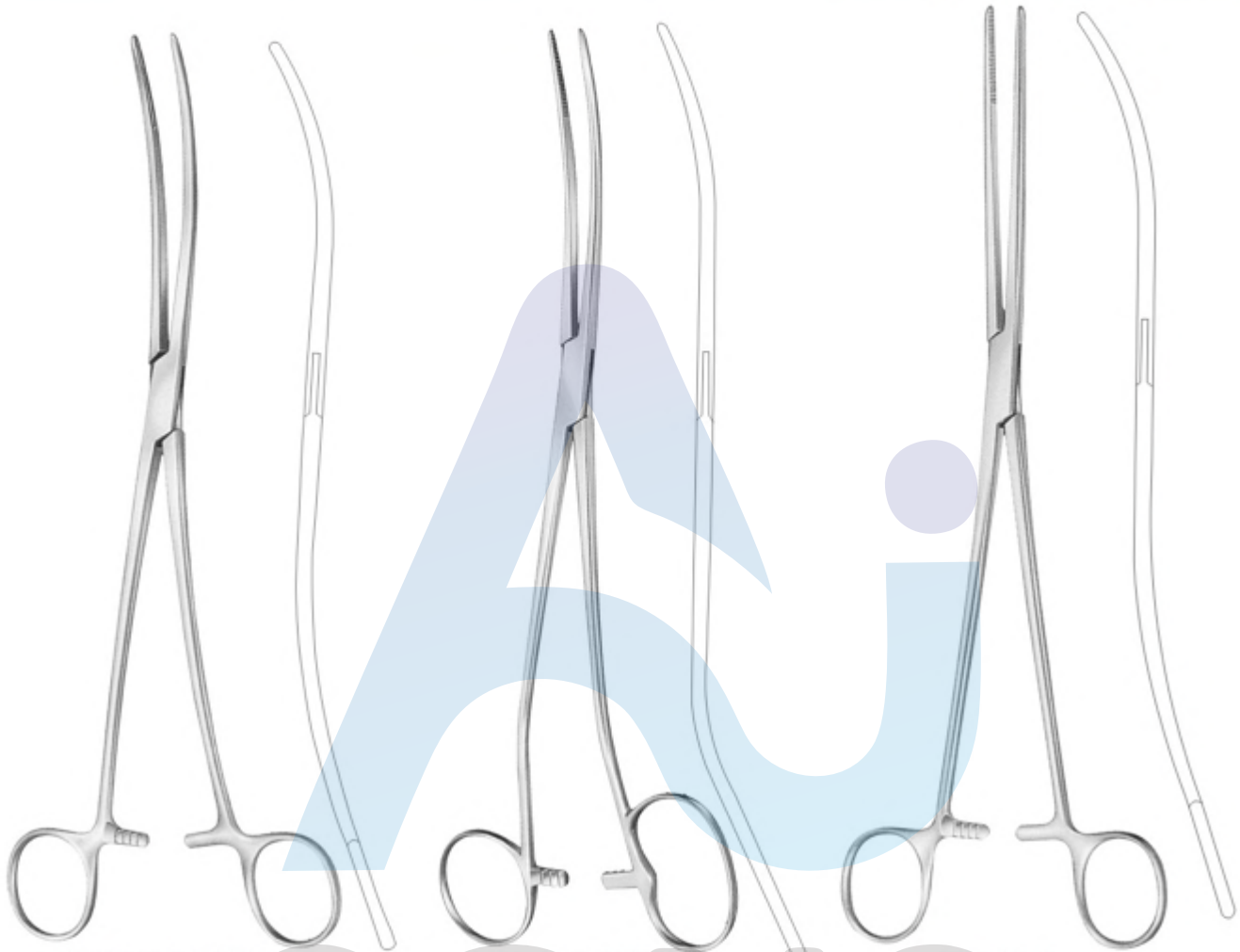

BOZEMANN UTERINE DRESSING FORCEPS
105-0076 255mm (10")
Jaws with longitudinal groove

BOZEMANN
105-0077 260mm (10.1/4")
Serrated jaws, on large bow

BOZEMANN
105-0078 250mm (10")
S-shaped curve



LISTER - SINUS



105-0079
125mm
(5")



105-0080
150mm
(6")



105-0081
180mm
(7")

●●● Haemostats Forceps



HALSTEAD MOSQUITO
106-0001 100mm (4")
Straight

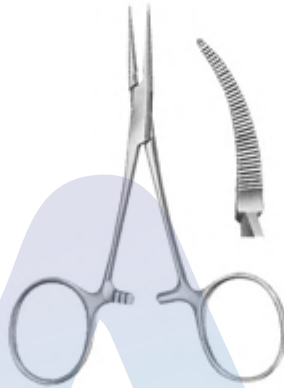

HALSTEAD MOSQUITO
106-0002 100mm (4")
Curved on flat



HALSTEAD MOSQUITO
100mm (4")
1 x 2 teeth
106-0003
Straight
106-0004
Curved on flat



HALSTEAD MOSQUITO
125mm (5")
106-0005
Straight
106-0006
Curved on flat



HALSTEAD MOSQUITO
125mm (5")
1 x 2 teeth
106-0007
Straight
106-0008
Curved on flat



BABY - CRILE
106-0009
140mm (5.1/2")
Straight



BABY-CRILE
106-0010 140mm (5.1/2")
Curved on flat

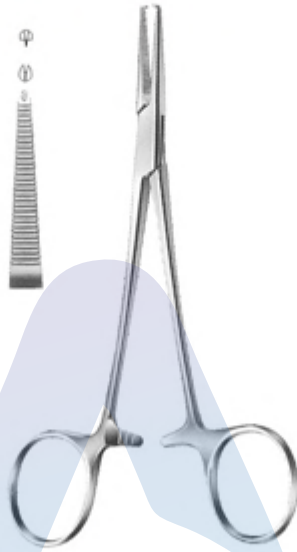

BABY-CRILE
106-0011 140mm (5.1/2")
Straight
1 x 2 teeth



BABY CRILE
106-0012 140mm (5.1/2")
Curved on flat
1 x 2 teeth



HALSTEAD MOSQUITO
125mm (5")
106-0013
Straight
106-0014
Curved on flat



HALSTEAD MOSQUITO
125mm (5")
1 x 2 teeth
106-0015
Straight
106-0016
Curved on flat

SONS

●●● Haemostats Forceps

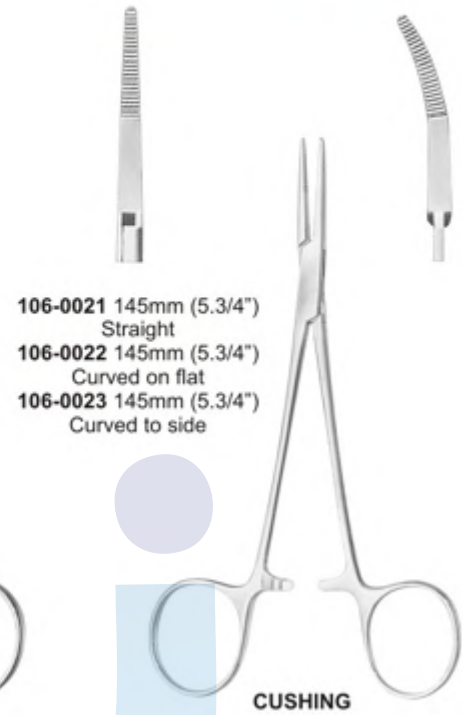
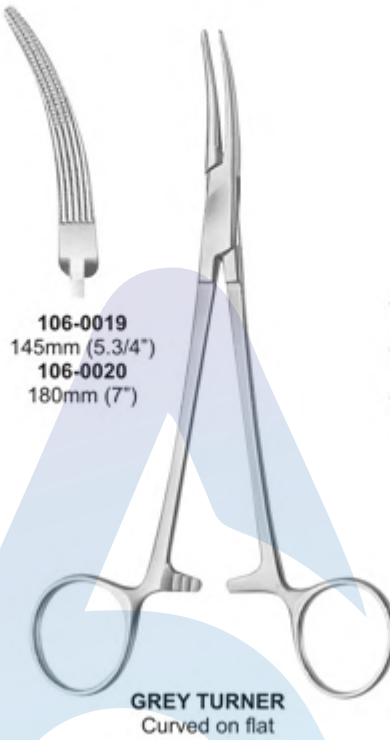



CRILE
1 x 2 teeth
106-0031 160mm (6.1/4")
Straight
106-0032 160mm (6.1/4")
Curved on flat
106-0033 140mm (5.1/2")
Straight
106-0034 140mm (5.1/2")
Curved on flat



CRILE
Curved on flat
106-0035 140mm (5.1/2")
106-0036 160mm (6.1/4")



KELLY-CRILE
Straight
106-0037 140mm (5.1/2")
106-0038 160mm (6.1/4")



KELLY
Curved on flat
106-0039 140mm (5.1/2")
106-0040 160mm (6.1/4")



KELLY HALSTEAD
106-0041 140mm (5.1/2")
Straight
106-0042 140mm (5.1/2")
Curved on flat



KOCHER
Straight 1 x 2 teeth
106-0043 125mm (5")
106-0044 140mm (5.1/2")
106-0045 150mm (6")
106-0046 180mm (7")
106-0047 200mm (8")
106-0048 225mm (9")

●●● Haemostats Forceps



KOCHER
Curved on flat 1 x 2 teeth
106-0049 125mm (5")
106-0050 140mm (5.1/2")
106-0051 150mm (6")
106-0052 180mm (7")
106-0053 200mm (8")
106-0054 225 (9")

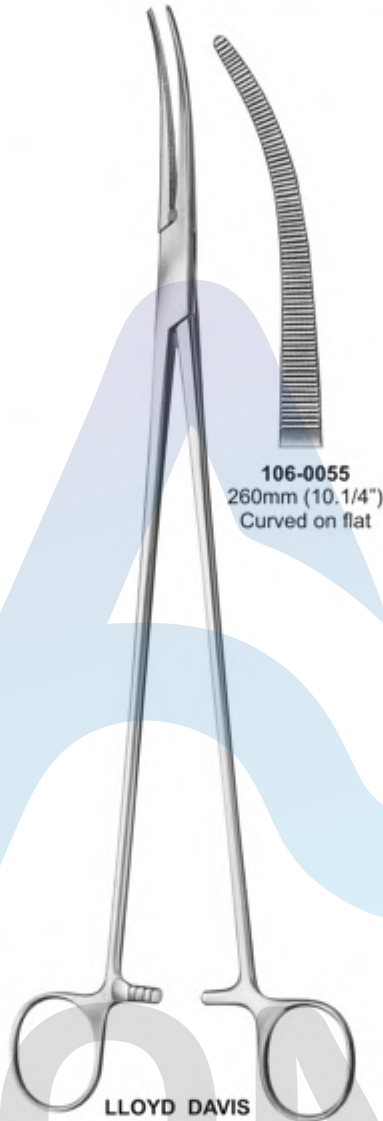

106-0055
260mm (10.1/4")
Curved on flat



MAYO
106-0056
160mm (6.1/4")
Curved on flat



ROCHESTER - OSCHNER
Straight 1 x 2 teeth

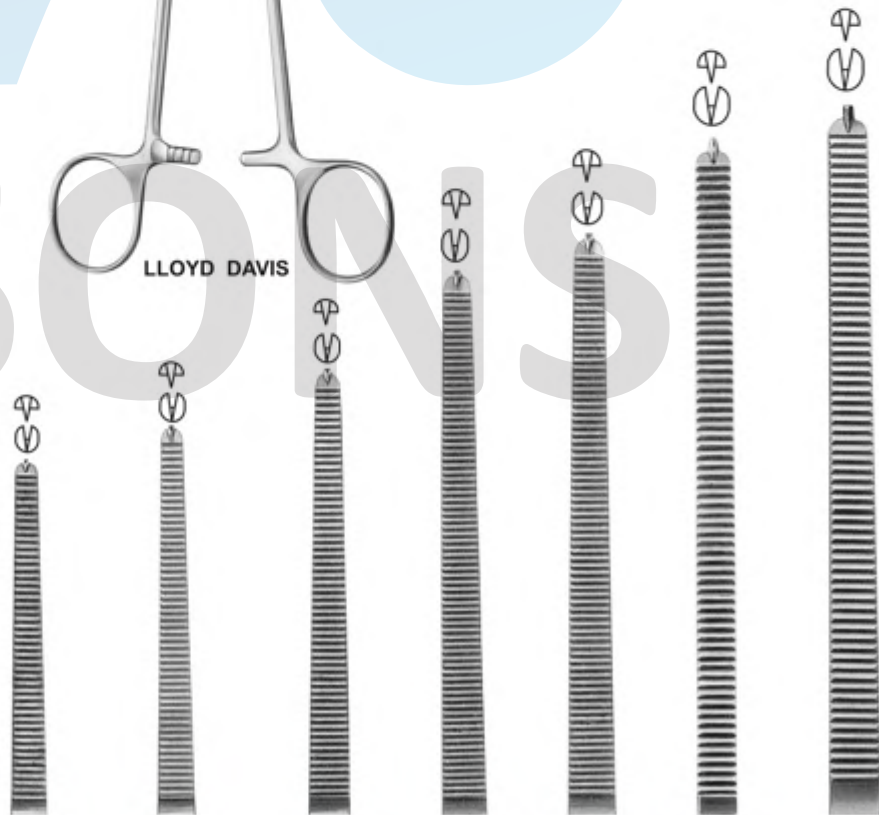

106-0057 140mm (5.1/2") **106-0058** 160mm (6.1/4") **106-0059** 185mm (7.1/4") **106-0060** 200mm(8") **106-0061** 225mm(9") **106-0062** 240mm(9.1/2") **106-0063** 260mm(10.1/4")

Haemostats Forceps ●●●

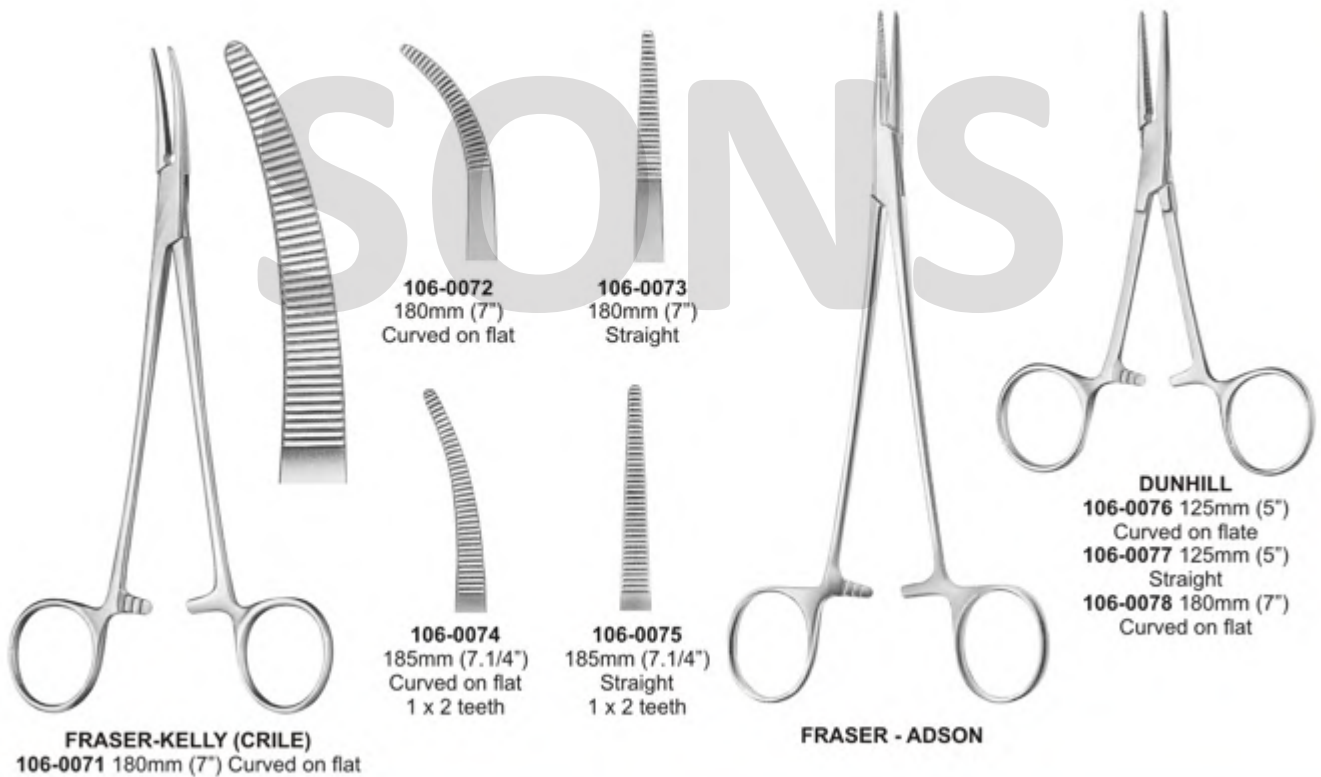
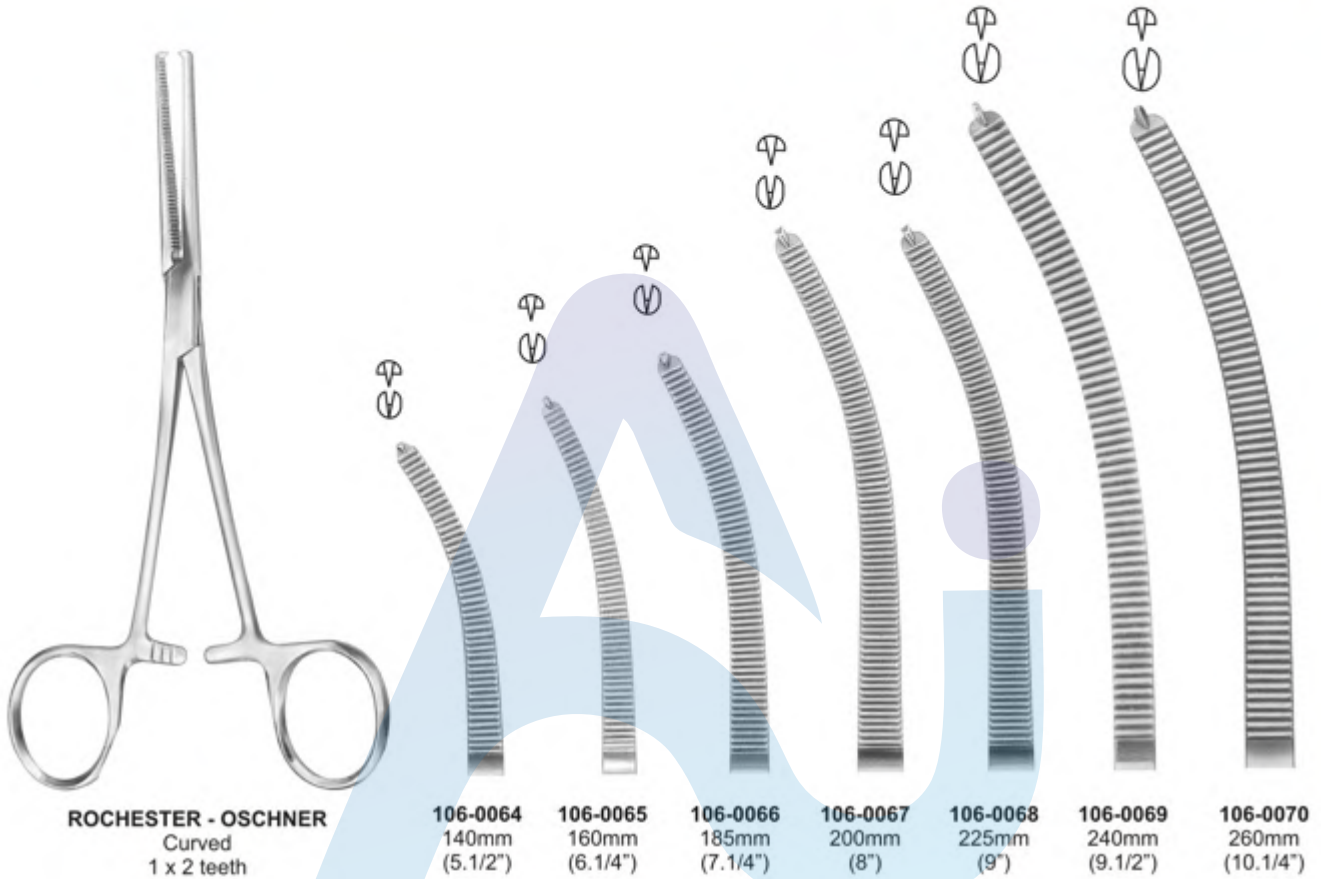

●●● Haemostats Forceps

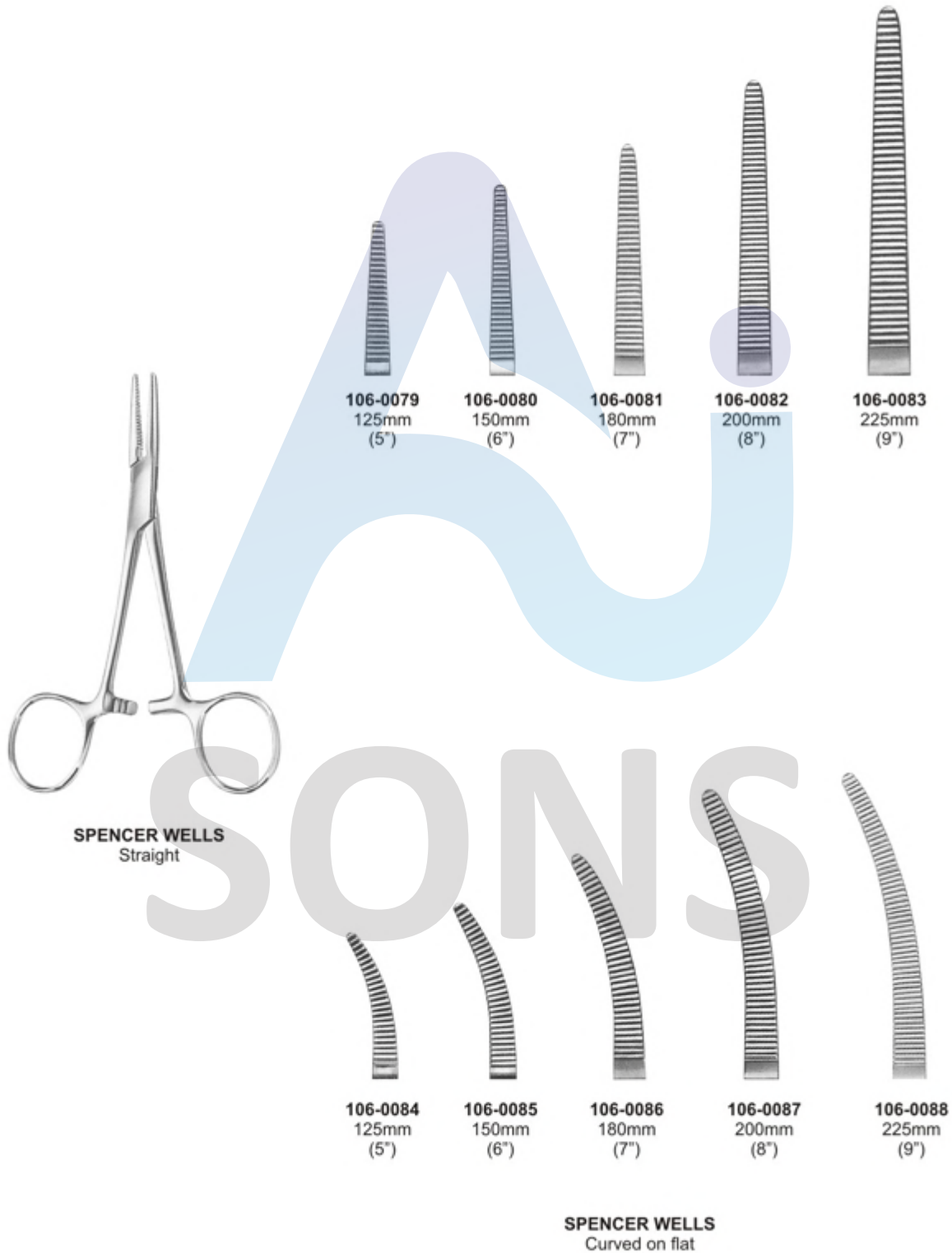

SPENCER WELLS
Straight

SPENCER WELLS
Curved on flat

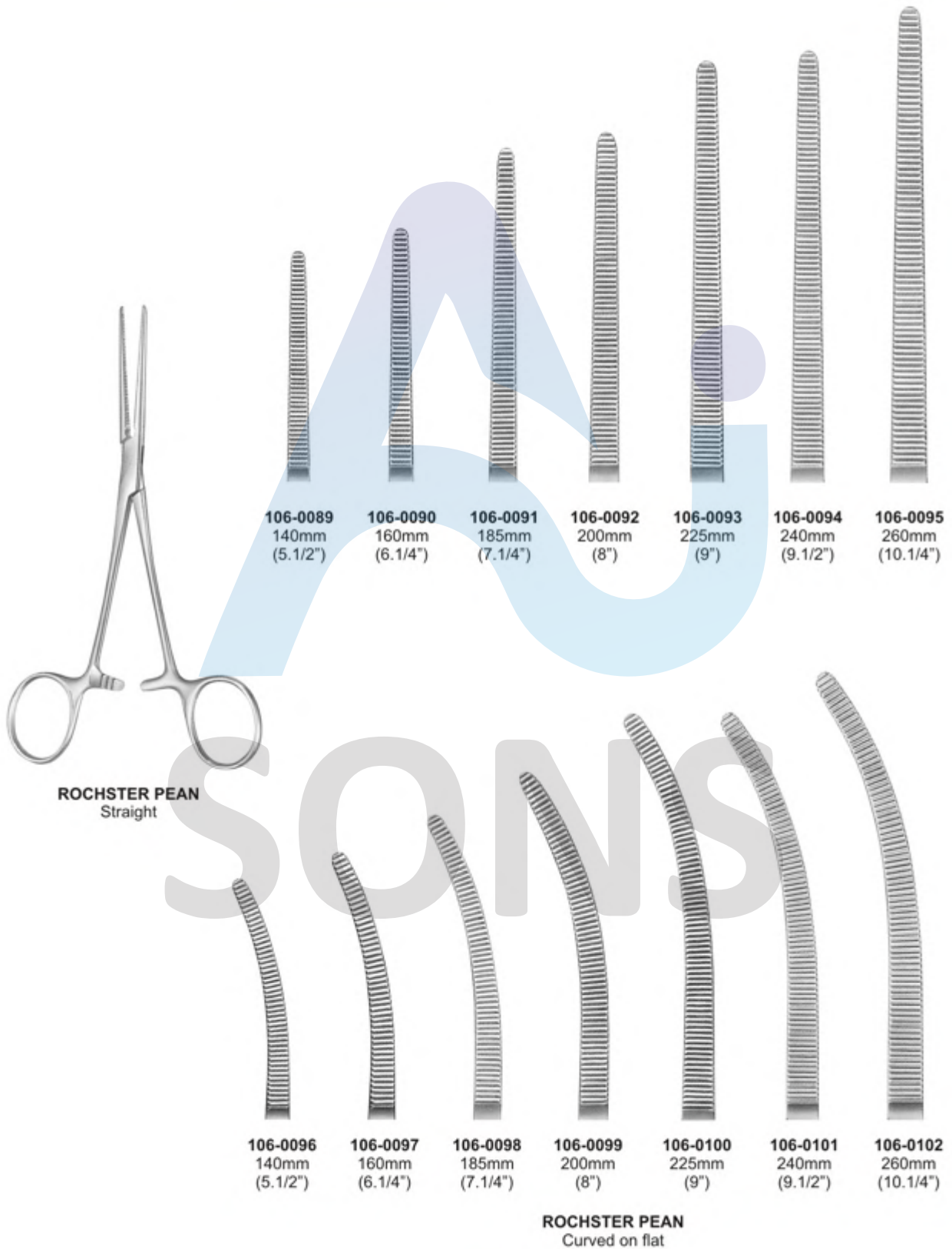

●●● Haemostats Forceps



HEISS
106-0103 200mm (8")
 Straight
106-0104 200mm (8")
 Curved on side
106-0105 200mm (8")
 Straight 1 x 2 teeth
106-0106 200mm (8")
 Curved on flat 1 x 2 teeth

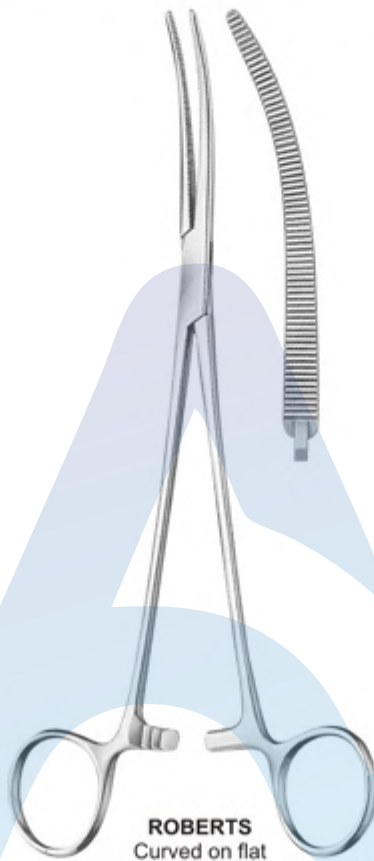

ROBERTS
 Curved on flat
106-0107 230mm (9")
 Screw joint
106-0108 230mm (9")
 Box joint



106-0109



106-0110

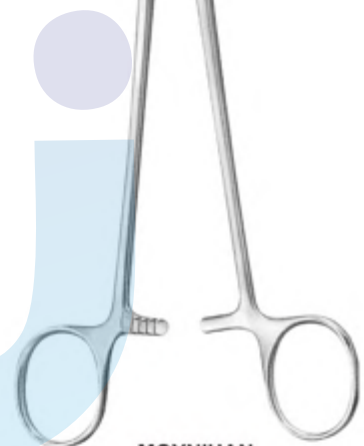

MOYNIHAN
106-0109 230mm (9")
106-0110 240mm (9.1/2")



MIXTER
 Curved on flat



106-0111
 140mm (5.1/2")



106-0112
 230mm (9")



106-0113
 180mm (7")



BIRKETT

106-0114 180mm (7")
 Straight
106-0115 180mm (7")
 Curved to side
106-0116 180mm (7")
 Curved on flat



106-0117
150mm
(6")

106-0118
180mm
(7")

106-0119
200mm
(8")

106-0120
230mm
(9")

106-0121
255mm
(10")

O'SHAUGHNESSY
Curved, lightweight



TUBING CLAMP
Heavy pattern.
wedge jaw

106-0122
150mm (6")

106-0123
180mm (7")

106-0124
200mm (8")



106-0125

106-0126

FICKLING ORAL

106-0127
180mm (7")
Angled to side
1 x 2 teeth

106-0128
180mm (7")
Angled to side

●●● Tonsil Artery Forceps

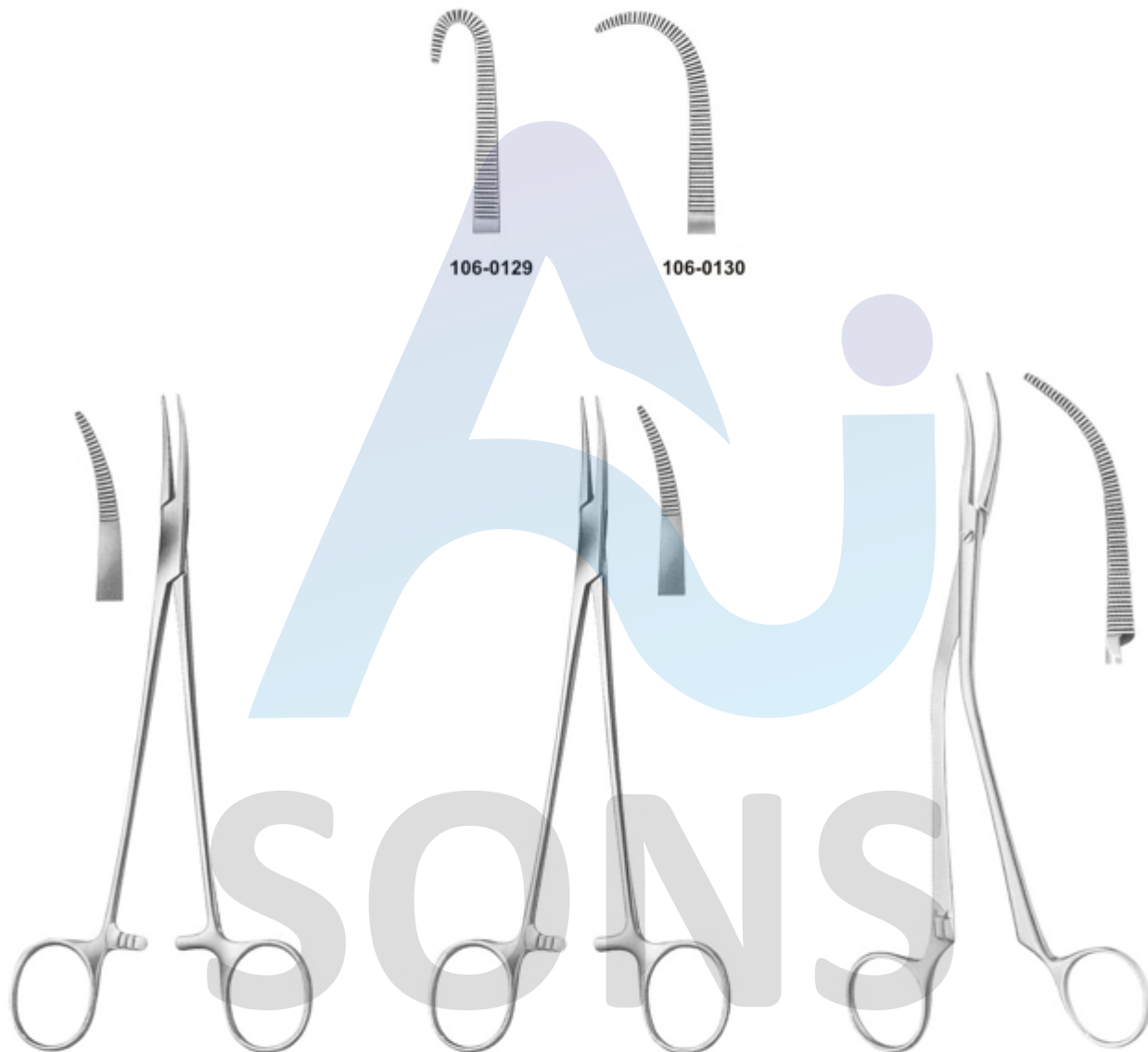

SCHNIDT TONSIL

106-0131
180mm (7")
Slight curved on flat

NEGUS TONSIL

106-0132
180mm (7")
Small curved

106-0133
180mm (7")
Large curved

WILSON TONSIL

106-0134
190mm (7.1/2")
Curved on flat
Angled shafts



CASTROVIEJO
107-0001
145mm (5.3/4")
With catch



CASTROVIEJO
107-0002
145mm (5.3/4")
With catch



ARRUGA
107-0003
135mm (5.1/4")



BARRAQUER
107-0004
120mm (4.3/4")
With catch



BARRAQUER
107-0005
120mm (4.3/4")
Without catch



CONVERSE
107-0006
125mm (5")

DERF
107-0007
120mm (4.3/4")

MAYO (DUNHILL)
107-0008
160mm (6.1/4")

MAYO
107-0009
180mm (7")

●●● Needle Holders



MAYO
107-0010 190mm (7.1/2")

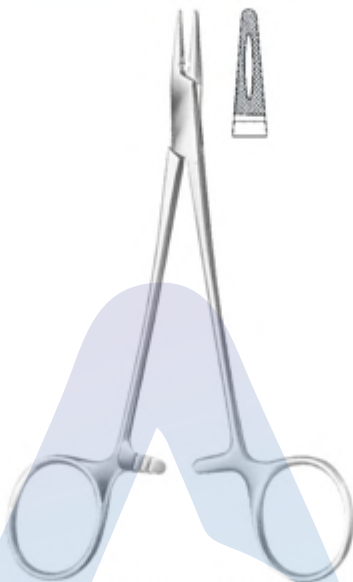

CRILE WOOD
107-0011 150mm (6")



CRILE MURRAY
107-0012 145mm (5.3/4")



KILNER
107-0013 135mm (5.1/4")



107-0014
190mm (7.1/2")
107-0015
250mm (10")

NAUNTUN MORGAN

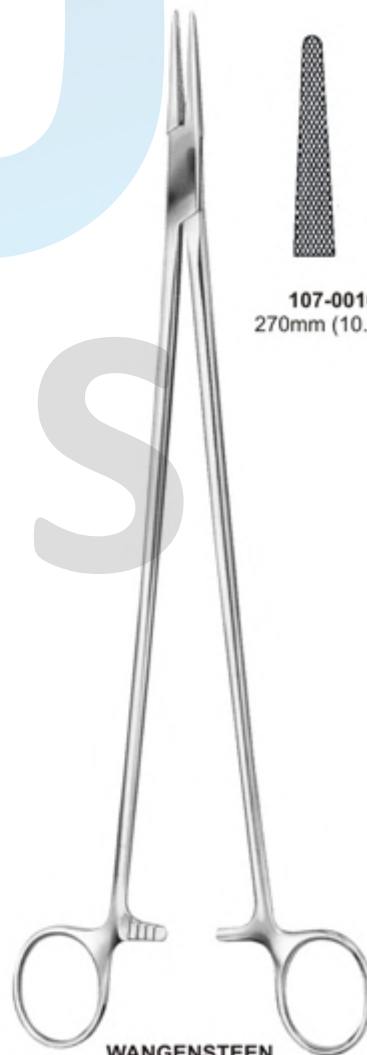

107-0016
270mm (10.3/4")

WANGENSTEEN



JAMESON
107-0016 230mm (9")



WRIGHT
107-0017 125mm (5")



GILLIES
Combined needle holder
and scissors
107-0018 160mm (6.1/4")

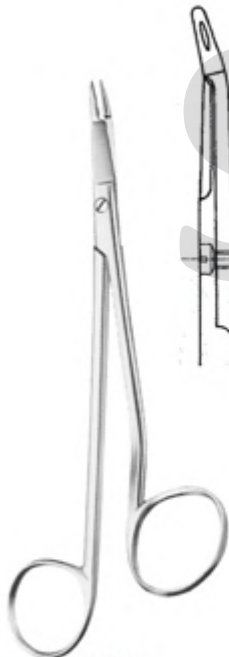

WARD
Combined needle holder
and scissors
107-0019 180mm (7")



HEANEY
107-0020 200mm (8")

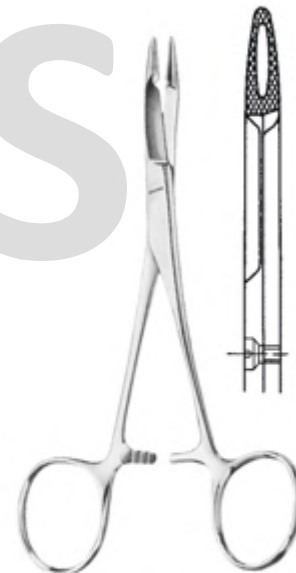

OLSEN HEGAR
Combined needle holder
and scissors
107-0021 140mm (5.1/2")
107-0022 165mm (6.1/2")
107-0023 190mm (7.1/2")

●●● Needle Holders



MAYO



MAYO (BAUMGARTNER)
107-0024 140mm (5.1/2")



MAYO (MASSON)
107-0025 265mm (10.1/2")



MAYO
107-0026 165mm (6.1/2")



107-0027
190mm (7.1/2")



107-0028
200mm (8")



107-0029
230mm (9")



HEGAR
107-0030
200mm (8")



HALSEY
107-0031
125mm (5")



MATHIEU
107-0032
140mm (5.1/2")



MATHIEU
107-0033
170mm (6.3/4")

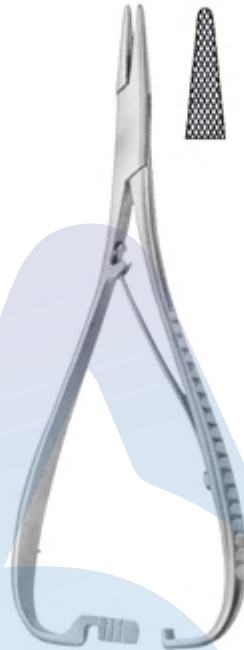

MATHIEU
107-0034
200mm (8")



WEBSTER
Smooth Jaw
107-0035
115mm (4.1/2")



MAYO
107-0036
150mm (6")



MCPHAILS
107-0037
180mm (7")



LAWRANCE
107-0038 150mm (6")
Lightweight
107-0039 150mm (6")

● ● ● Probes

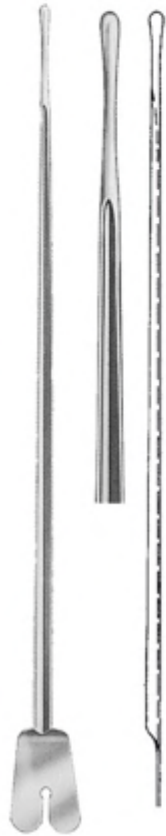

BRODIE
107-0040
200mm (8")
Ball point



DIRECTORS
107-0041 130mm (5.1/8")
107-0042 145mm (5.3/4")
107-0043 160mm (6.1/4")



107-0044
140mm (5.1/2")



SINUS
107-0045
150mm (6")



PROBE
With Eye

- PROBE**
- 107-0046 127mm (5")
- 107-0047 152mm (6")
- 107-0048 178mm (7")
- 107-0049 200mm (8")
- 107-0050 255mm (10")
- 107-0051 305mm (12")

SONS



MYRTLE LEAF PROBE
107-0052
145mm (5.3/4")



1mm Tip
107-0053
145mm (5.3/4")

1.5mm tip

- 107-0054 130mm (5.1/8")
- 107-0055 145mm (5.3/4")
- 107-0056 160mm (6.1/4")
- 107-0057 180mm (7")
- 107-0058 200mm (8")
- 107-0059 250mm (10")

2mm tip

- 107-0060 145mm (5.3/4")
- 107-0061 160mm (6.1/4")
- 107-0062 180mm (7")
- 107-0063 200mm (8")



LIEBRICH LACHRYMAL
107-0064
No. 00 - 0 (0.7 - 0.8mm)
107-0065
No. 1 - 2 (0.9 - 1.1mm)
107-0066
No. 3 - 4 (1.3 - 1.4mm)
107-0067
No. 5 - 6 (1.5 - 1.6mm)



ANEL LACHRYMAL
107-0068
108mm (4.1/4") 0.6mm , small



JOBSON HORNE
107-0069 140mm (5.1/2")
107-0070 178mm (7")



FISTULA PROBE
107-0071 240mm (9.1/2")



**KINGS COLLEGE HOSPITAL
COCAINISING WIRE**
107-0072 89mm (3.1/2")
107-0073 133mm (5.1/4")



LOGAN TURNER
107-0074 120mm (4.3/4")
1.00mm diameter



CAWTHORNE
107-0075
140mm (5.1/2")

SONS

● ● ● Dissectors

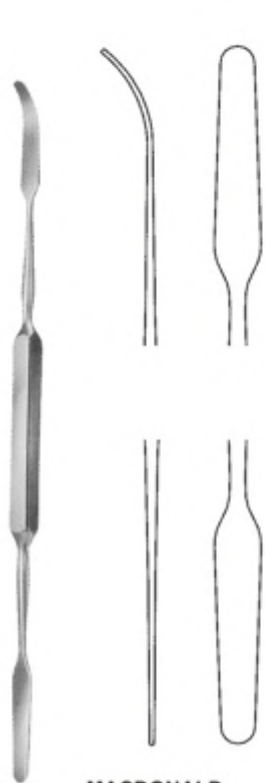

MACDONALD
107-0076 185mm (7.1/4")
Double ended



WATSON CHEYNE
Fine with probe
107-0077 125mm (5")
107-0078 190mm (7.1/2")

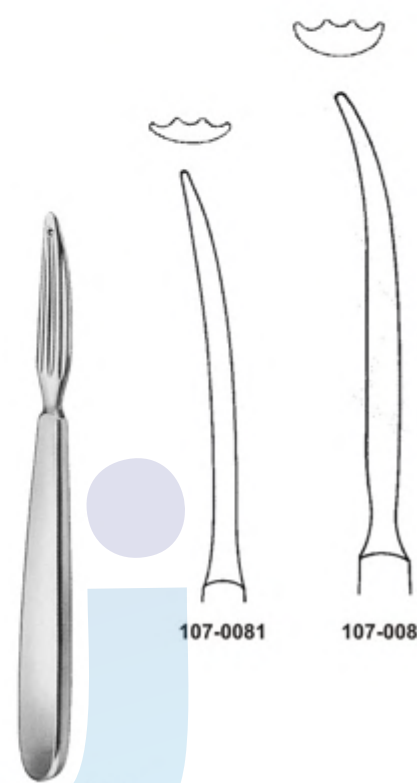

KOCHER THYROID
107-0079 150mm(6")
107-0080 170mm (6.3/4")

107-0081

107-0082



KOCHER THYROID
107-0083 190mm (7.1/2")



KING
107-0084 195mm (7.3/4")



KING
107-0085 200mm (8")



PAYR
107-0086 225mm (9")

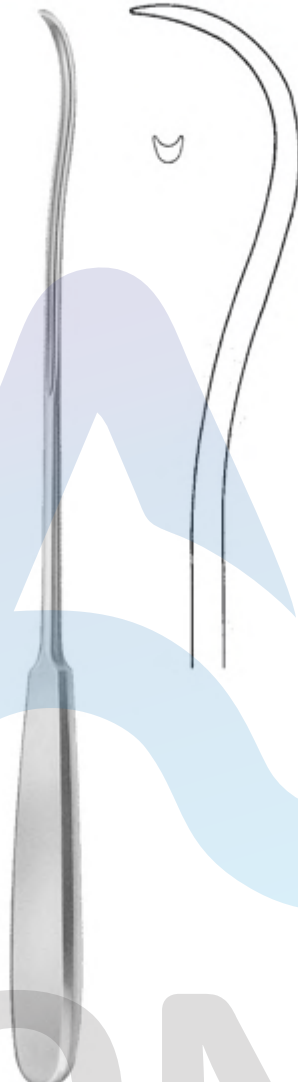

PAYR
107-0087 280mm (11")



GWYNNE EVANS TONSIL
200mm (8")
Double ended
107-0088 6mm wide
107-0089 8mm wide



LITTAUER
107-0090 110mm (4.1/2")
With hook end



LITTAUER (SPENCER)
107-0091 80mm (3.1/2")
With hook end



CHARNLEY SUTURE FORCEPS



107-0092
180mm (7")
107-0093
125mm (5")

●●● Hand Held Retractors



**DEAVER
108-0001**
215mm (8.1/2")
Blade: 22mm wide

**DEAVER
108-0002**
300mm (12")
Blade: 25mm wide

**DEAVER
108-0003**
315mm (12.1/2")
Blade: 25mm wide

**DEAVER
108-0004**
300mm (12")
Blade: 38mm wide

**DEAVER
108-0005**
310mm (12.1/4")
Blade: 50mm wide



DEAVER GRIP

No 1
108-0006
310mm (12.1/4")
Blade: 25mm wide

DEAVER GRIP

No 2
108-0007
310mm (12.1/4")
Blade: 38mm wide

DEAVER GRIP

No 3
108-0008
302mm (12")
Blade: 50mm wide

DEAVER GRIP

No 4
108-0009
310mm (12.1/4")
Blade: 75mm wide

●●● Hand Held Retractors



RICHARDSON
240mm (9.1/2")



108-0010
Blade: 23mm x 20mm

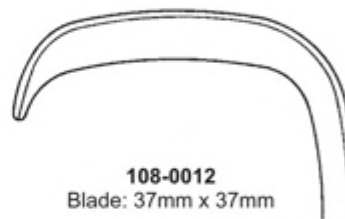

108-0012
Blade: 37mm x 37mm

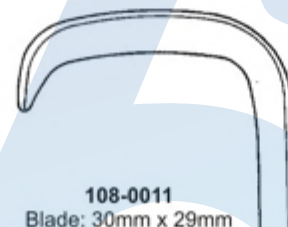

108-0011
Blade: 30mm x 29mm

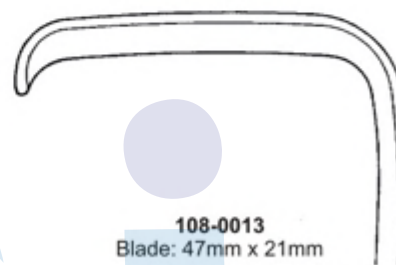

108-0013
Blade: 47mm x 21mm

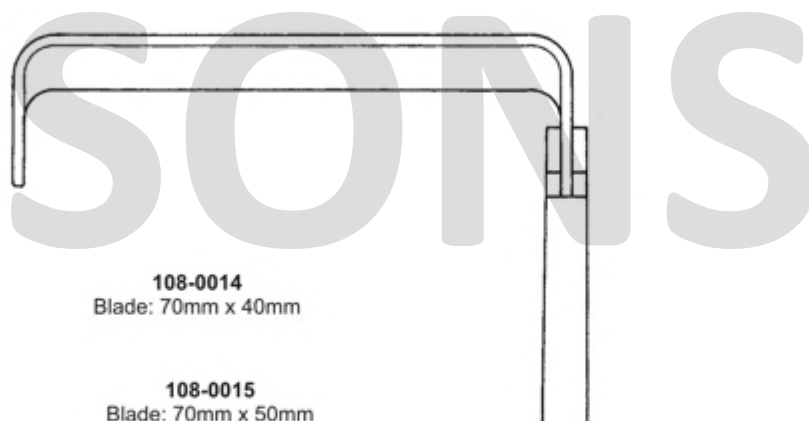

108-0014
Blade: 70mm x 40mm

108-0015
Blade: 70mm x 50mm

108-0016
Blade: 70mm x 65mm



MORRIS
245mm (9.3/4")
Single blade

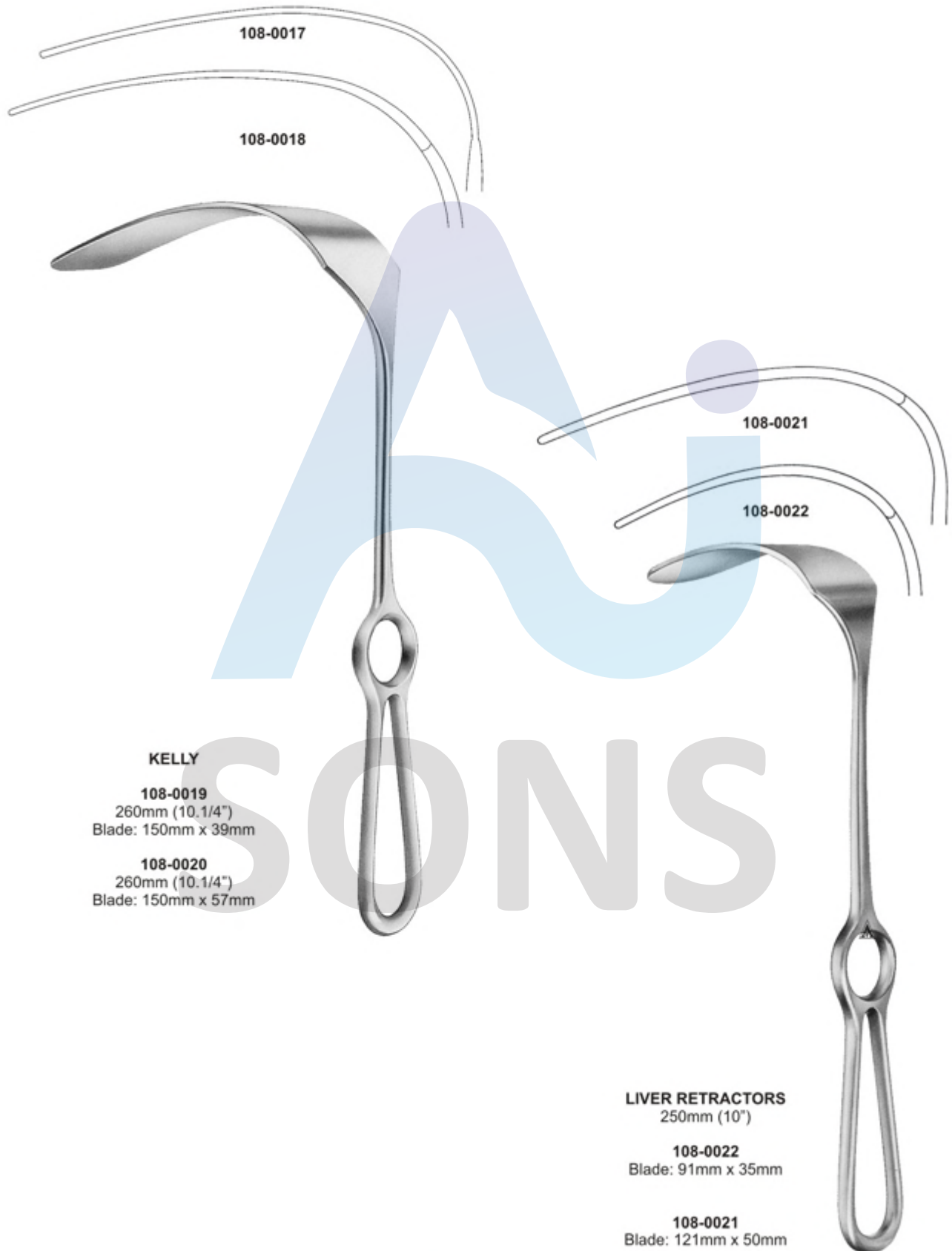

KELLY

108-0019
260mm (10.1/4")
Blade: 150mm x 39mm

108-0020
260mm (10.1/4")
Blade: 150mm x 57mm

LIVER RETRACTORS
250mm (10")

108-0022
Blade: 91mm x 35mm

108-0021
Blade: 121mm x 50mm

●●● Hand Held Retractors



MIDDELDORPF



108-0023
220mm (8.3/4")
Blade: 15mm x 15mm



108-0024
215mm (8.1/2")
Blade: 20mm x 22mm



108-0025
235mm (9.1/4")
Blade: 28mm x 28mm



DURHAM
215mm (8.1/2")
108-0026 Blade: 10mm
108-0027 Blade: 16mm



KOCHER
108-0028 230mm (9")
Blade: 36mm x 20mm



MOYNIHAN
205mm (8")
108-0029 Blade: 20mm x 15mm
108-0030 Blade: 20mm x 12mm



108-0031



108-0032



LANGENBECK
215mm (8.1/2")

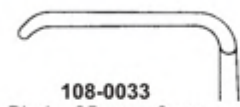

108-0033
Blade: 25mm x 6mm

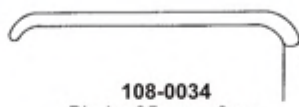

108-0034
Blade: 35mm x 8mm

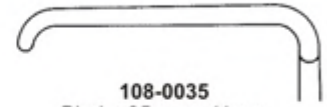

108-0035
Blade: 35mm x 11mm

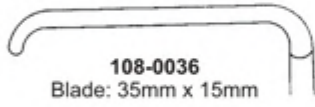

108-0036
Blade: 35mm x 15mm

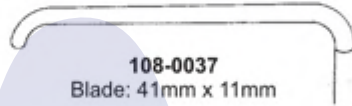

108-0037
Blade: 41mm x 11mm

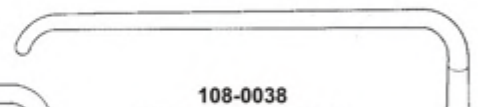

108-0038
Blade: 55mm x 11mm

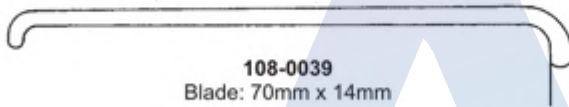

108-0039
Blade: 70mm x 14mm



108-0040
Blade: 80mm x 16mm

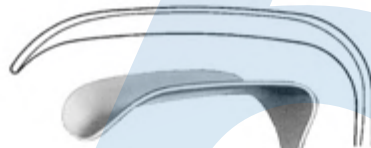

KOCHER
108-0041 250mm (10")
Blade: 67mm x 25mm



CUSHINGS VEIN
RETRACTORS
250mm (10")



108-0042
Blade: 14mm x 11mm



108-0043
Blade: 18mm x 13mm



108-0044
Blade: 22mm x 15mm

●●● Hand Held Retractors



KOCHER
230mm (9")

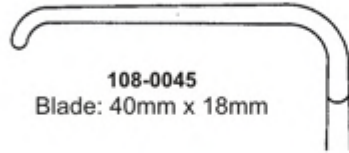

108-0045
Blade: 40mm x 18mm

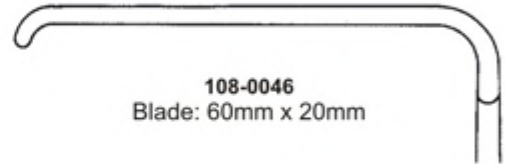

108-0046
Blade: 60mm x 20mm

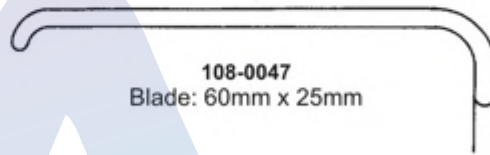

108-0047
Blade: 60mm x 25mm

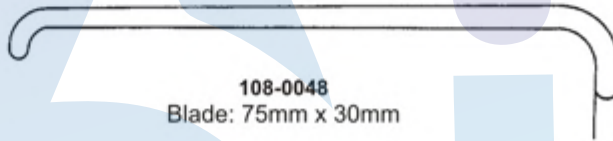

108-0048
Blade: 75mm x 30mm

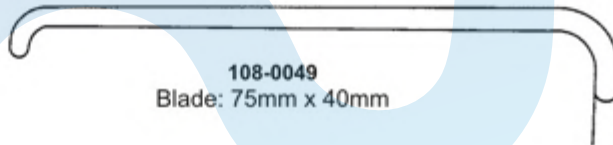

108-0049
Blade: 75mm x 40mm



FARABEUF 125mm (5")
108-0050
Set consisting of
Inner blade: 22mm x 10mm
28mm x 12mm
Outer blade: 25mm x 10mm
32mm x 12mm



FARABEUF 150mm (6")
108-0051
Set consisting of
Inner blade: 20mm x 16mm
24mm x 16mm
Outer blade: 23mm x 16mm
28mm x 16mm



WALTON
305mm (12") Malleable
108-0052 13mm wide
108-0053 25mm wide
108-0054 38mm wide
108-0055 51mm wide



SIMON
108-0056
220mm (8.3/4")

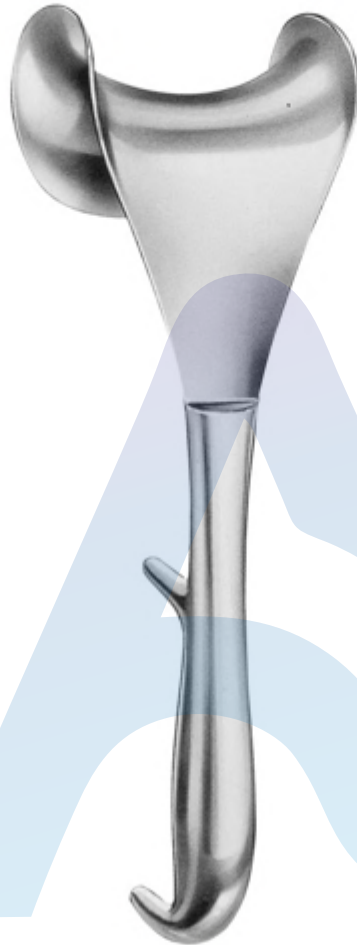

DOYEN
108-0057 250mm (10")
Blade: 53mm x 80mm



DOYEN
240mm (9.1/2")
108-0058
Blade: 60mm x 45mm
108-0059
Blade: 90mm x 45mm
108-0060
Blade: 120mm x 45mm

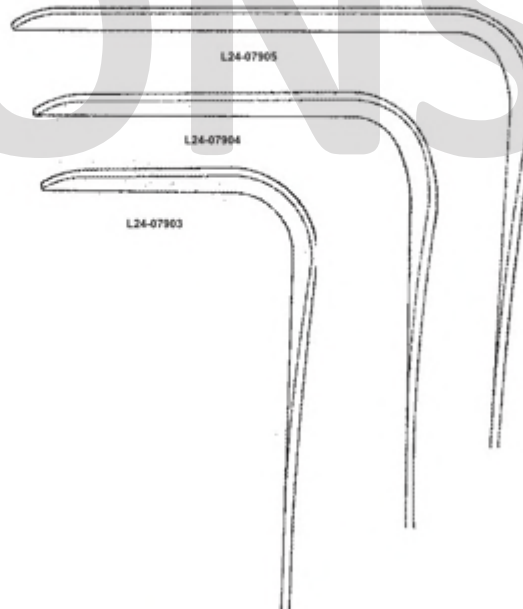

SONS

●●● Hand Held Retractors

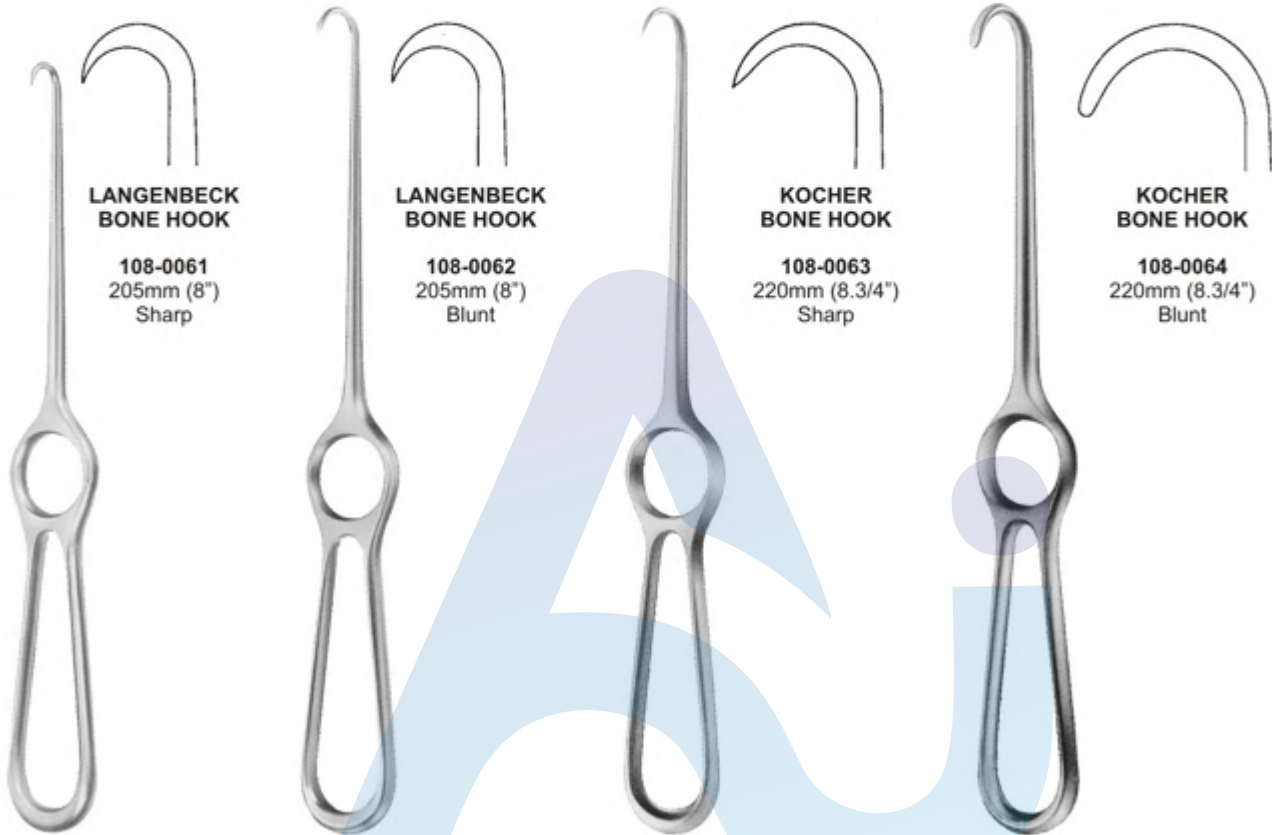

**LANGENBECK
BONE HOOK**

108-0061
205mm (8")
Sharp

**LANGENBECK
BONE HOOK**

108-0062
205mm (8")
Blunt

**KOCHER
BONE HOOK**

108-0063
220mm (8.3/4")
Sharp

**KOCHER
BONE HOOK**

108-0064
220mm (8.3/4")
Blunt

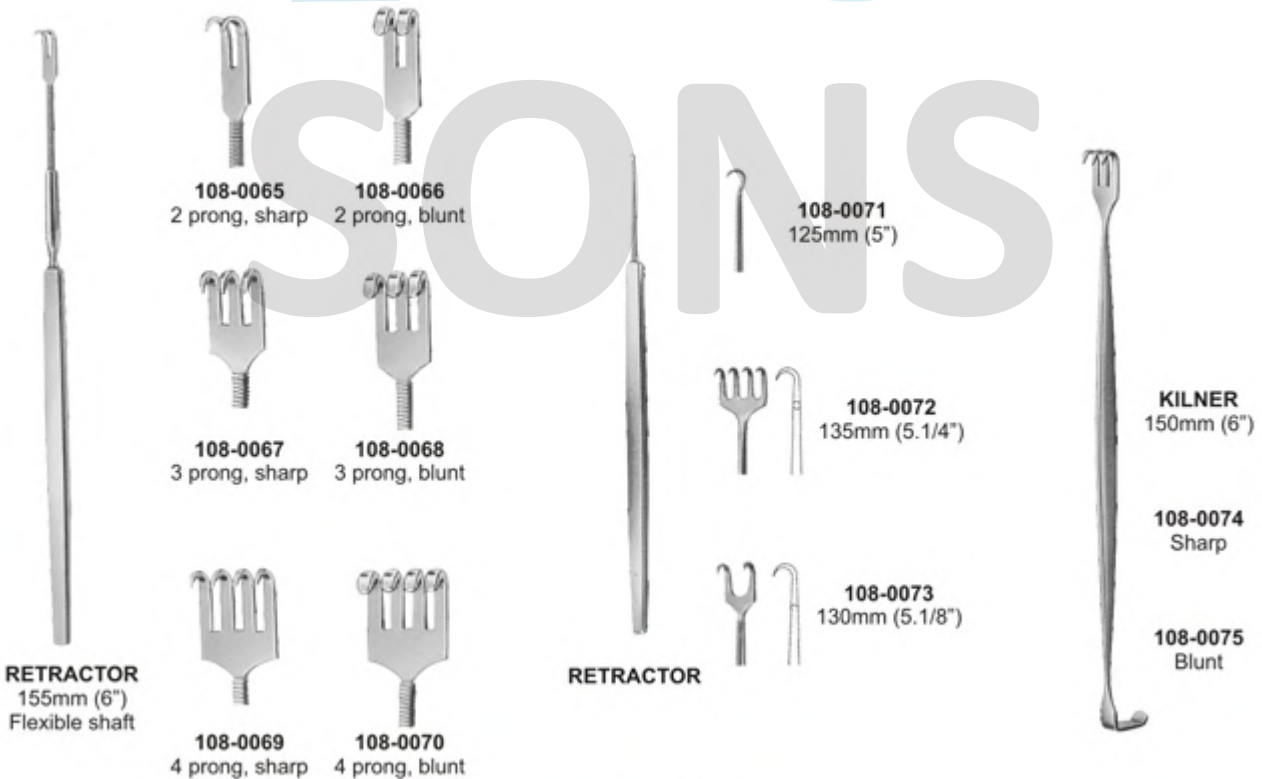

108-0065
2 prong, sharp

108-0066
2 prong, blunt

108-0071
125mm (5")

108-0067
3 prong, sharp

108-0068
3 prong, blunt

108-0072
135mm (5.1/4")

KILNER
150mm (6")

RETRACTOR
155mm (6")
Flexible shaft

RETRACTOR

108-0074
Sharp

108-0069
4 prong, sharp

108-0070
4 prong, blunt

108-0073
130mm (5.1/8")

108-0075
Blunt



RICARD
108-0076
 Lateral blades: 58mm x 80mm
 Centre blade: 54mm x 70mm
108-0077
 Lateral blades: 72mm x 84mm
 Centre blade: 72mm x 90mm

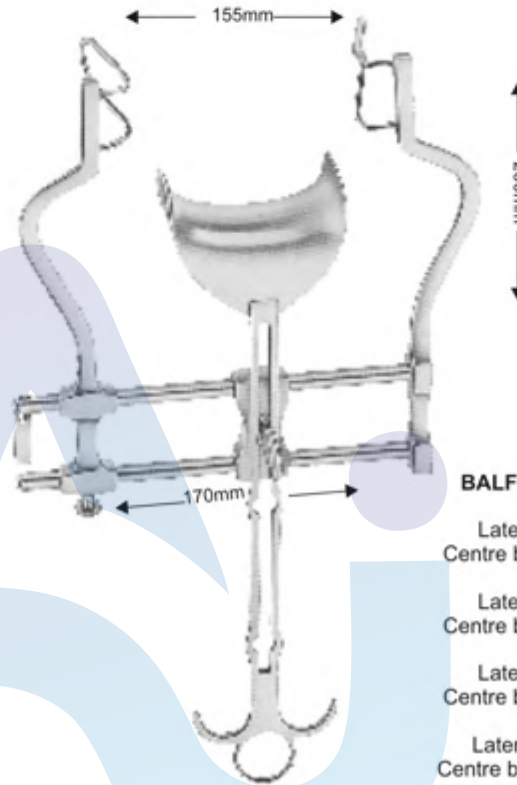

BALFOUR ABDOMINAL
108-0078
 Lateral blades: 60mm
 Centre blade: 47mm x 80mm
108-0079
 Lateral blades: 60mm
 Centre blade: 62mm x 76mm
108-0080
 Lateral blades: 90mm
 Centre blade: 80mm x 80mm
108-0081
 Lateral blades: 105mm
 Centre blade: 59mm x 107mm

KIRSCHNER RETRACTOR SET

- 108-0082**
 Set comprising of:
 1 x **108-0083**
 2 x **108-0084**
 2 x **108-0085**

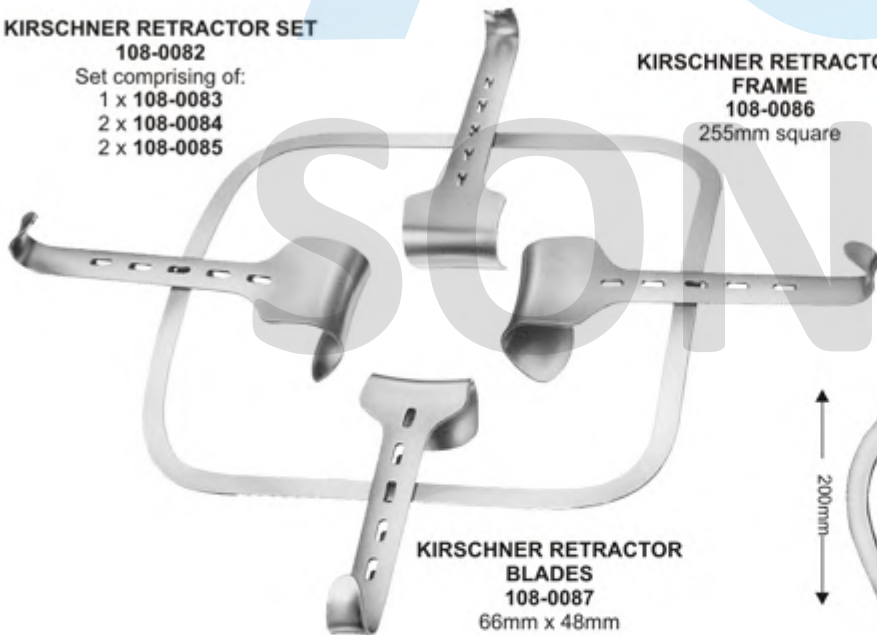

KIRSCHNER RETRACTOR

- FRAME**
108-0086
 255mm square

KIRSCHNER RETRACTOR

- BLADES**
108-0087
 66mm x 48mm
108-0088
 54mm x 42mm
108-0089
 64mm x 80mm

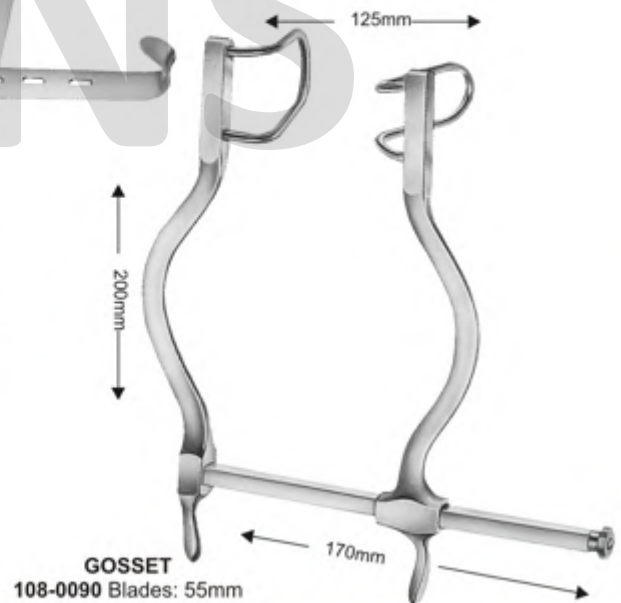

GOSSET
108-0090 Blades: 55mm

●●● Hand Held Retractors



GOLIGHER

108-0091
Complete with two centre blades: 51mm deep, and four lateral blades:
2 x 51mm deep
2 x 102mm deep

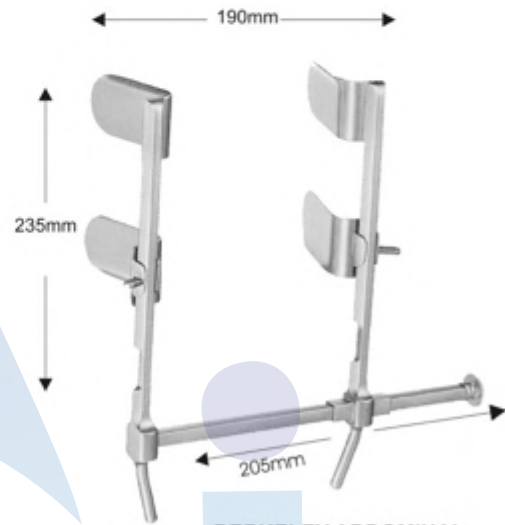

BERKELEY ABDOMINAL

108-0092
Blades: 35mm x 60mm



TRAVERS

108-0093
200mm (8")
4 x 5 teeth
Blunt



IRWIN

108-0094
178mm (7")
4 x 5 teeth
Sharp



WEISLANDER
108-0095 110mm (4.3/8")
2 x 3teeth, sharp



WEISLANDER
108-0096 110mm (4.3/8")
2 x 3 teeth, blunt



RNTNE HOSPITAL
108-0097 159mm (6.1/4")
3 x 4 teeth



NORFOLK AND NORWICH
108-0098 215mm (8.1/2")
4 x 5 teeth, blunt



WEISLANDER
3 x 4 teeth, blunt
108-0099
130mm (5.1/8")
108-0100
156mm (6.1/2")



WEISLANDER
3 x 4 teeth, sharp
108-0101
130mm (5.1/8")
108-0102
165mm (6.1/2")



WEISLANDER
3 x 4 teeth, semi sharp
108-0103
130mm (5.1/8")
108-0104
165mm (6.1/2")

●●● Hand Held Retractors



WEISLANDER



108-0105
195mm (7.3/4")
3 x 4 teeth
sharp



108-0106
240mm (9.1/2")
3 x 4 teeth
sharp



108-0107
255mm (10")
5 x 6 teeth
sharp



108-0108
195mm (7.3/4")
3 x 4 teeth
blunt



108-0109
240mm (9.1/2")
3 x 4 teeth
blunt



108-0110
255mm (10")
5 x 6 teeth
blunt



CONE

108-0111
145mm (5.3/4")



JANSON (SHEA)

108-0112
105mm (4.1/8")

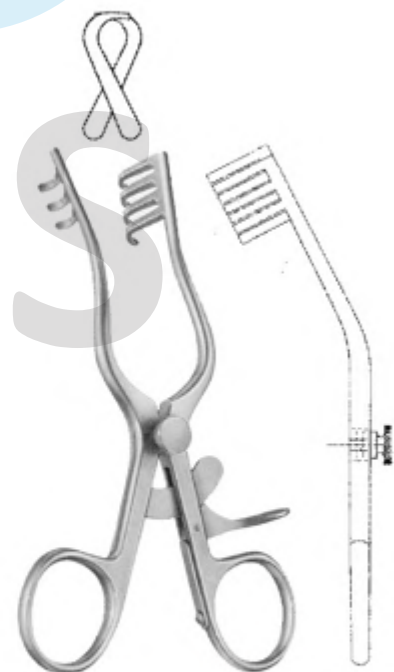

JEFFERSON

108-0113
140mm (5.1/2")

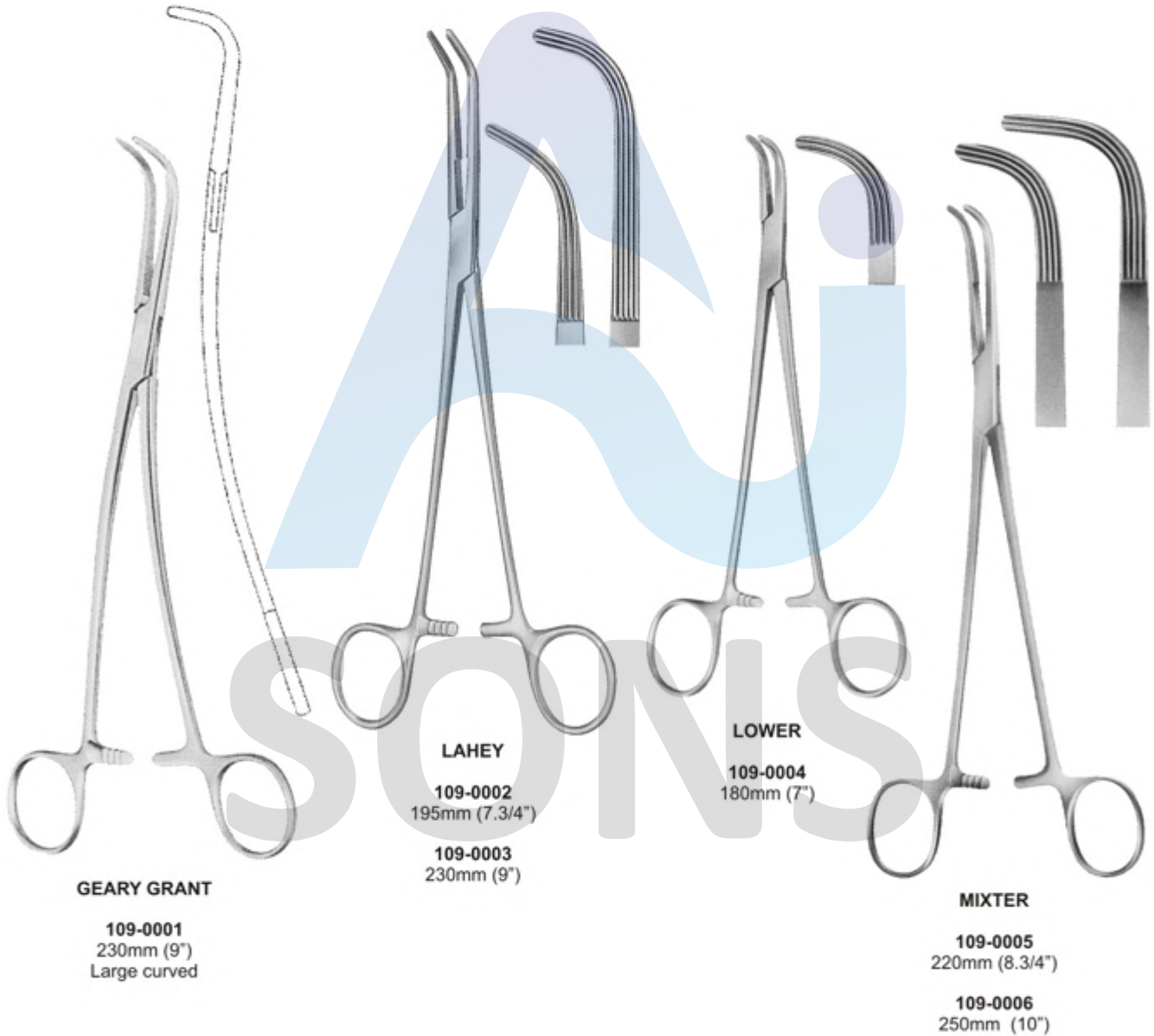

●●● Cholecystectomy & Gall Stone

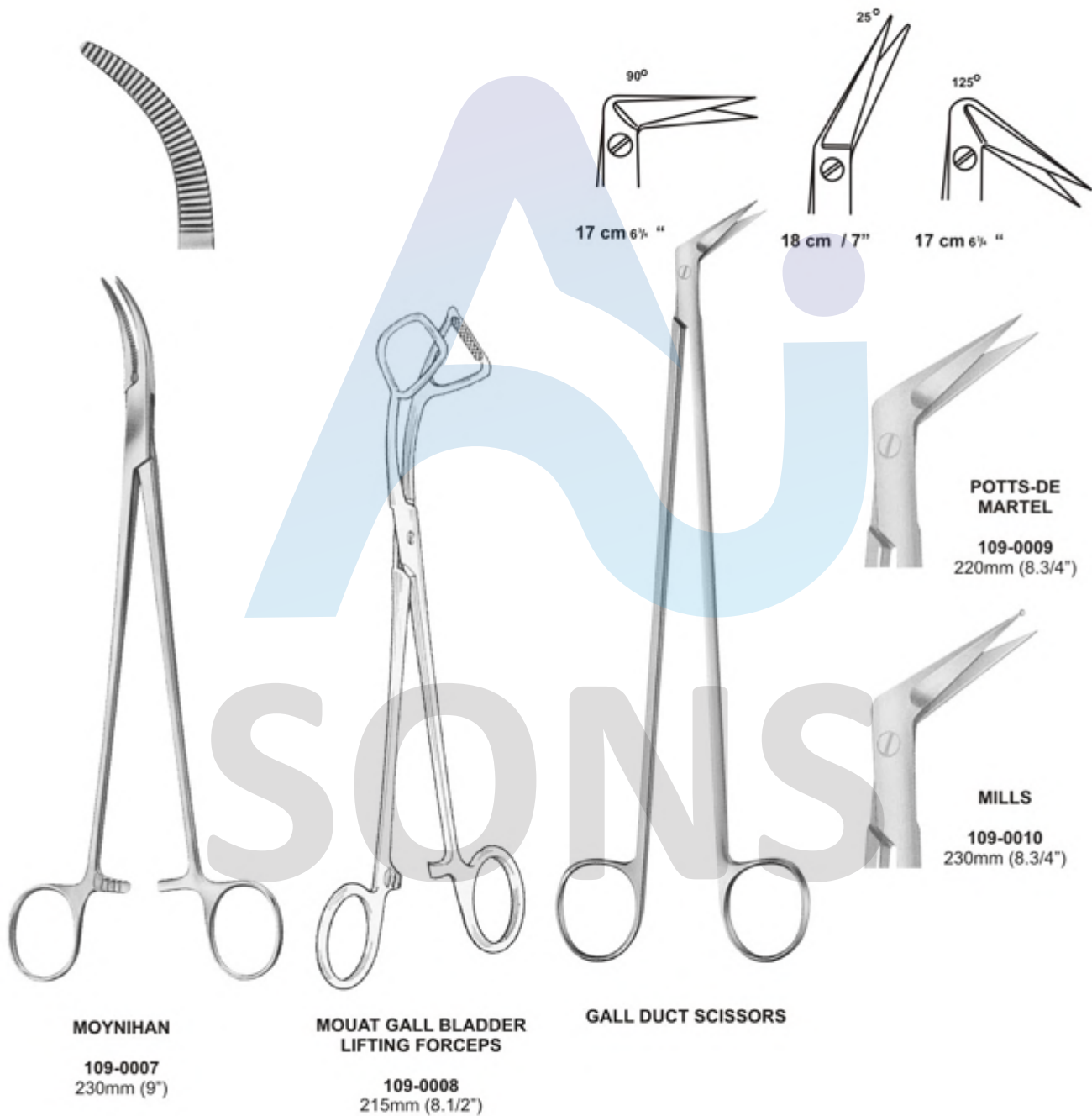



109-0011
Straight

109-0012
Curved



109-0013
Straight

109-0014
Curved



109-0015
Straight

109-0016
Curved

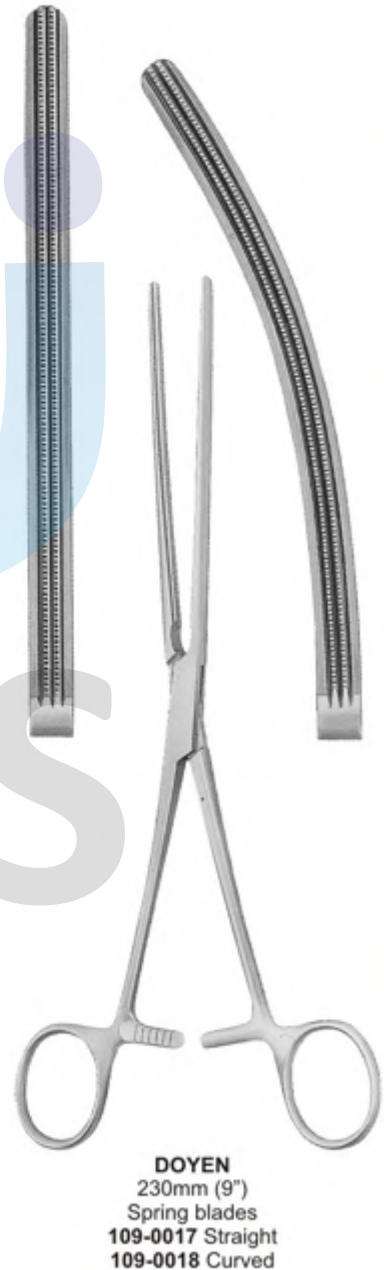

DOYEN
230mm (9")
Spring blades
109-0017 Straight
109-0018 Curved

●●● Intestinal Clamps



DOYEN (KOCHER)
 Straight, light spring blade
109-0019
 230mm (9")
109-0020
 250mm (10")
109-0021
 280mm (11")
109-0022
 210mm (8.1/4")

DOYEN (MAYO ROBSON)
 Curved, light spring blade
109-0023
 230mm (9")
109-0024
 250mm (10")
109-0025
 280mm (11")
109-0026
 210mm (8.1/4")

KOCHER
 Spring blades
109-0027
 250mm (10")
109-0028
 280mm (11")



LANE
109-0029
210mm (8.1/4")

**SETON PRINGLE
(BAINBRIDGE)**
109-0030
150mm (6") Straight
109-0031
150mm (6") Curved

DOYEN (MAYO ROBSON)
Spring blades
109-0032
250mm (10")
109-0033
280mm (11")

●●● Intestinal Clamps



SCHOEMAKER
Hollow blades for
hemisphincterectomy
109-0034
170mm (6.3/4")
109-0035
215mm (8.1/2")

PARKER KERR
Anastomosis forceps for
colon resection
109-0036
250mm (10")

LANG STEVENSON
109-0037
200mm (8")

PAYR
109-0038
200mm (8")
Jaw: 65mm
109-0039
280mm (11")
Jaw: 100mm
109-0040
350mm (14")
Jaw: 150mm

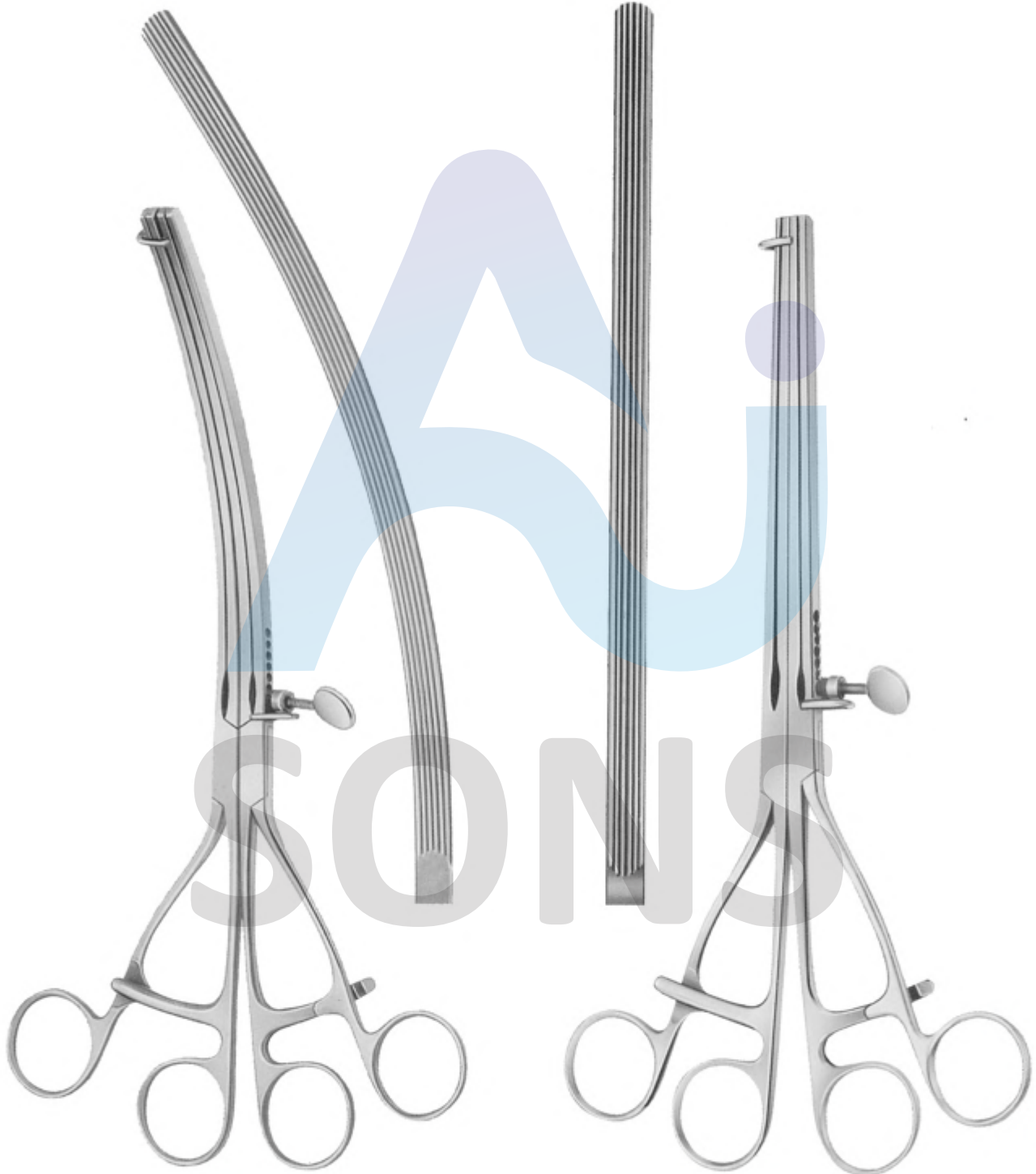

LANE TWIN ANASTOMOSIS
109-0041
300mm (12") Curved

LANE TWIN ANASTOMOSIS
109-0042
300mm (12") Straight

●●● Vaginal Speculum



CUSCO
110-0001 75mm x 17mm
Extra small for virgins



GRAVE
110-0004 75mm x 20mm
110-0005 95mm x 30mm
110-0006 195mm x 33mm

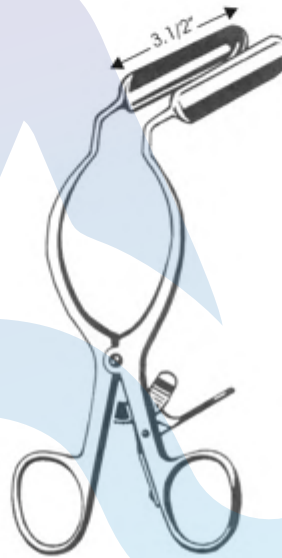

**McGEE LATERAL
VIGINAL RETRACTOR**
with ratch handle
110-0003



CUSCO
110-0002 75mm x 17mm
Extra small for virgins



CUSCO
110-0007 110mm x 37mm
110-0008 80mm x 32mm
110-0009 80mm x 24mm



PEDERSON
110-0010 100mm x 22 mm
110-0011 120mm x 25mm

SIMS
111-0001
 125mm (5")
 Small
 70mm x 26mm
 75mm x 30mm
111-0002
 150mm (6")
 Medium
 75mm x 30mm
 80mm x 35mm
111-0003
 175mm (7")
 Large
 80mm x 36mm
 90mm x 40mm



111-0004
 175mm (7")
 Blade:
 70mm x 15mm



111-0008
 175mm (7")
 Blade:
 70mm x 10mm



111-0005
 180mm (7")
 Blade:
 70mm x 27mm



111-0009
 180mm (7")
 Blade:
 75mm x 23mm



111-0006
 180mm (7")
 Blade:
 75mm x 30mm



111-0010
 180mm (7")
 Blade:
 80mm x 25mm



111-0007
 185mm (7.1/4")
 Blade:
 90mm x 36mm



111-0011
 185mm (7.1/4")
 Blade:
 100mm x 32mm



KRISTELLE

KRISTELLE

●●● Vaginal Speculum

MATHIEU

111-0012
210mm (8.1/4")
Blade:
95mm x 17-30mm
For children and virgins

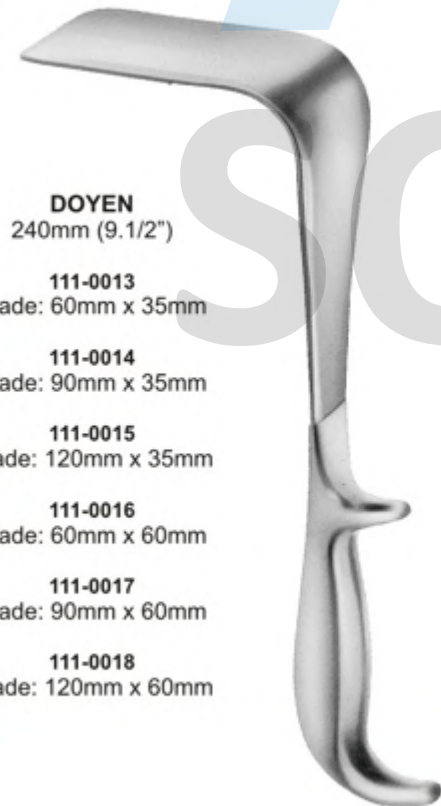

DOYEN

240mm (9.1/2")

111-0013
Blade: 60mm x 35mm

111-0014
Blade: 90mm x 35mm

111-0015
Blade: 120mm x 35mm

111-0016
Blade: 60mm x 60mm

111-0017
Blade: 90mm x 60mm

111-0018
Blade: 120mm x 60mm



MODIFIED WERTHEIM

320mm (12.3/4")

111-0019
Blade: 100mm x 25mm

111-0020
Blade: 100mm x 30mm

111-0021
Blade: 100mm x 35mm

111-0022
Blade: 100mm x 40mm



KOGAN ENDOCERVICAL SPECULUM

111-0023
240mm (9.1/2")
Graduated

AUVARD

111-0024
230mm (9")
Blade: 63mm x 38-28mm
Weight: 1.53 Kg (3lb, 60z)
Fixed weight



AUVARD

230mm (9")
Weight: 1.47kg (3lb, 4oz)
with detachable weight

111-0025
Blade: 75mm x 42-40mm

111-0026
Blade: 105mm x 43-40mm

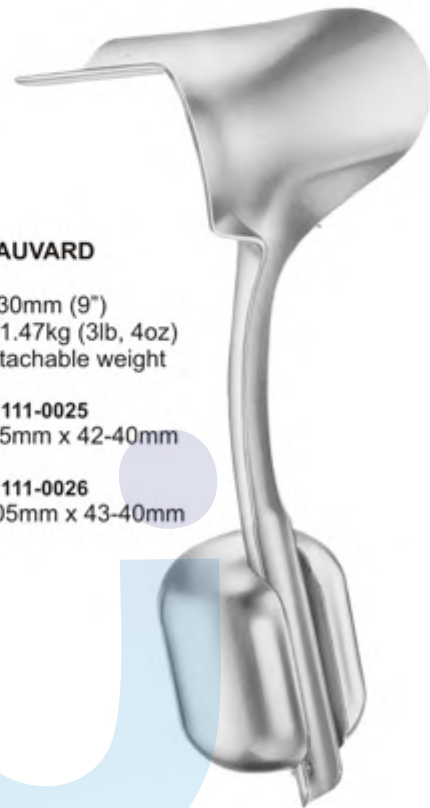

O6-09443

Set of twelve

- 111-0027** 6mm
- 111-0028** 7mm
- 111-0029** 8mm
- 111-0030** 9mm
- 111-0031** 10mm
- 111-0032** 11mm
- 111-0033** 12mm
- 111-0034** 13mm
- 111-0035** 14mm
- 111-0036** 15mm
- 111-0037** 16mm
- 111-0038** 17mm



HAWKIN AMBLER
170mm (6.3/4")
Cervix dilator

111-0039

Set of sixteen
consisting of one of
each of: 111-0040 to 111-0056

- | | | |
|----------------------|-----------------------|------------------------|
| 111-0040 2mm | 111-0052 13mm | 111-0063 8.5mm |
| 111-0042 3mm | 111-0053 14mm | 111-0064 9.5mm |
| 111-0043 4mm | 111-0054 15mm | 111-0065 10.5mm |
| 111-0044 5mm | 111-0055 16mm | 111-0066 11.5mm |
| 111-0045 6mm | 111-0056 17mm | 111-0067 12.5mm |
| 111-0046 7mm | 111-0057 2.5mm | 111-0068 13.5mm |
| 111-0047 8mm | 111-0058 3.5mm | 111-0069 14.5mm |
| 111-0048 9mm | 111-0059 4.5mm | 111-0070 15.5mm |
| 111-0049 10mm | 111-0060 5.5mm | 111-0071 16.5mm |
| 111-0050 11mm | 111-0061 6.5mm | 111-0072 17.5mm |
| 111-0051 12mm | 111-0062 7.5mm | |



HEGAR
185mm (7.1/4")
Cervix dilator

●●● Uterine Dilators / Probes



HEGAR
205mm (8")
Cervix dilator
Double ended

111-0073
Set of eight consisting
of one of each of:
111-0074 to 111-0082

- 111-0074 1mm - 2mm
- 111-0075 3mm - 4mm
- 111-0076 5mm - 6mm
- 111-0077 7mm - 8mm
- 111-0078 9mm - 10mm
- 111-0079 11mm - 12mm
- 111-0080 13mm - 14mm
- 111-0081 15mm - 16mm
- 111-0082 17mm - 18mm

4mm

3mm



GALABIN

111-0083
290mm (11.1/2")
Shaft graduated
is cm's
Malleable



SIMS

111-0084
330mm (13")

111-0085
330mm (13")
Malleable



MARTIN

111-0086
300mm (12")

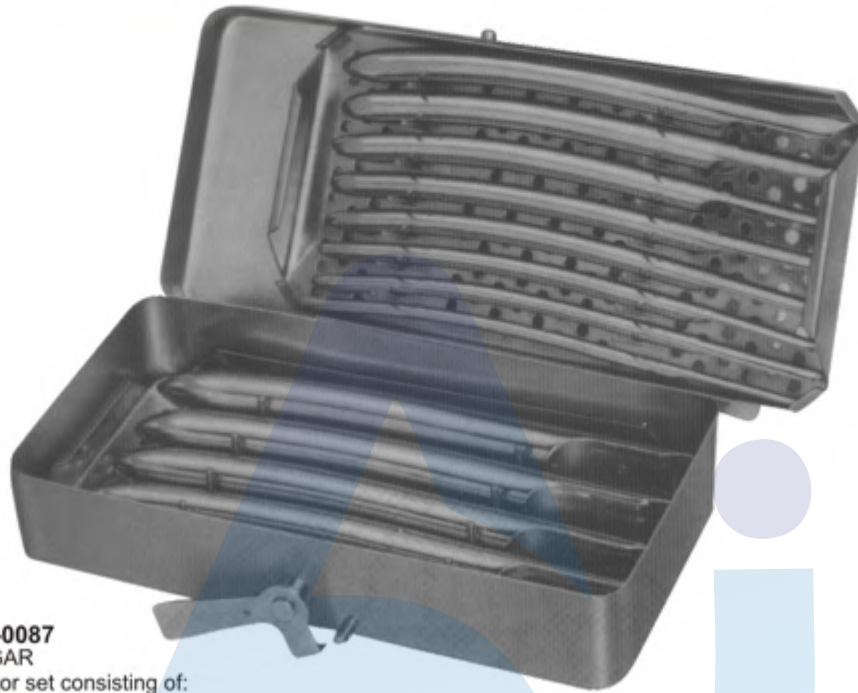

111-0087
HEGAR
Dilator set consisting of:
14 Dilators,
1 Rack for dilators (4- 12 mm)
1 Rack for Dilators (13 - 17 mm)
1 Metal case only,
with hinged lid, stainless 200 X 100 X 35 mm



111-0088
HEGAR
Dilator set consisting of:
26 Dilators,
1 Rack for dilators (1- 17 mm)
1 Rack for Dilators (18 - 26 mm)
1 Metal case only,
with hinged lid, aluminium 330 X 220 X 80 mm

●●● Tenaculum Forceps



BROWN

112-0001
250mm (10")
Slender

SCHROEDER

112-0002
230mm (9")

WILSON

112-0003
240mm (9.1/2")



HEYWOOD SMITH

112-0004
240mm (9.1/2")

MCLINTOCK

112-0005
240mm (9.1/2")

NOTO

112-0006
280mm (11")

●●● Ovum Forceps

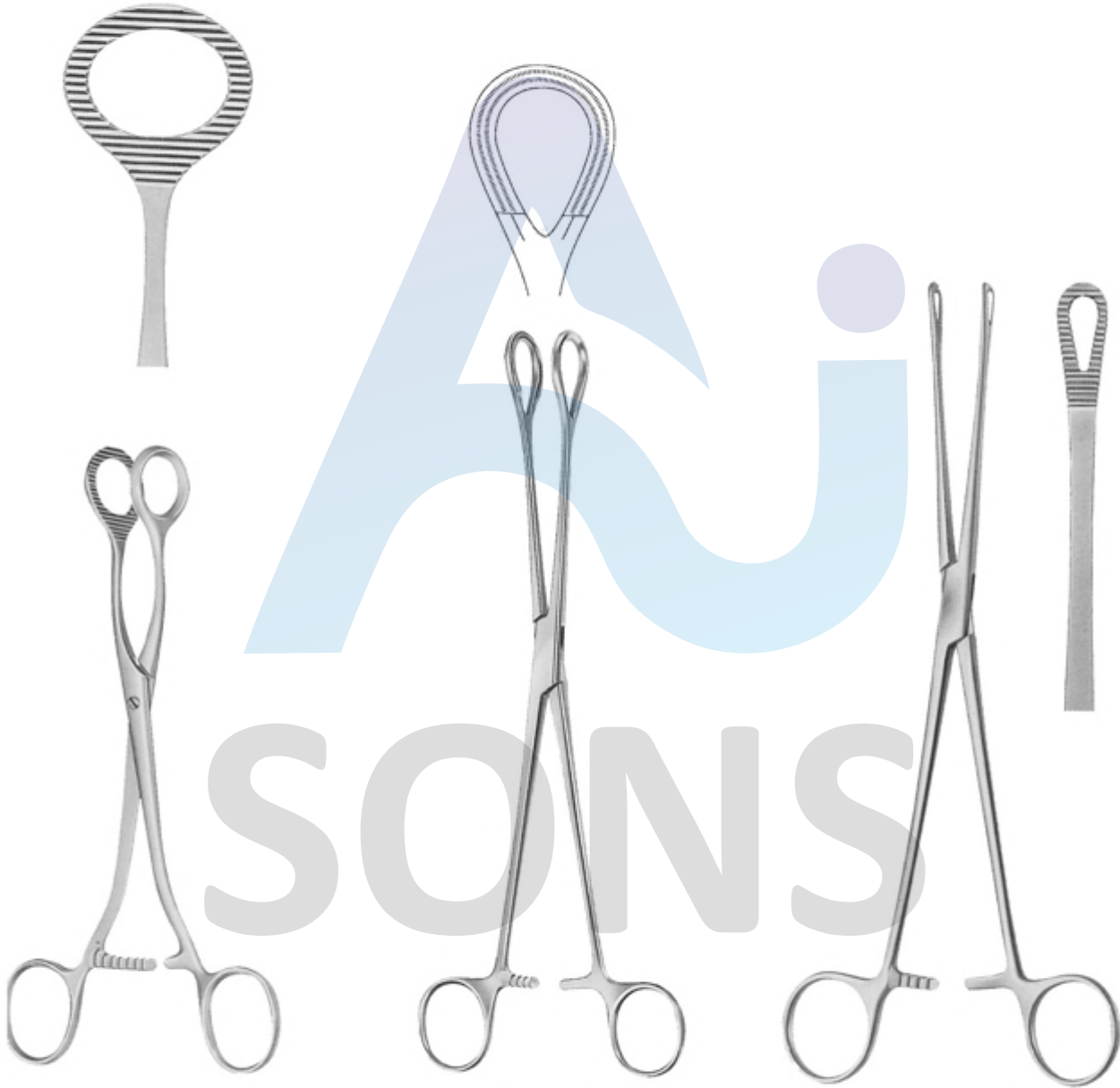

DOYEN
112-0007
185mm (7.1/4")

112-0008
250mm (10")

BONNEY POLYPI
112-0009
240mm (9.1/2")

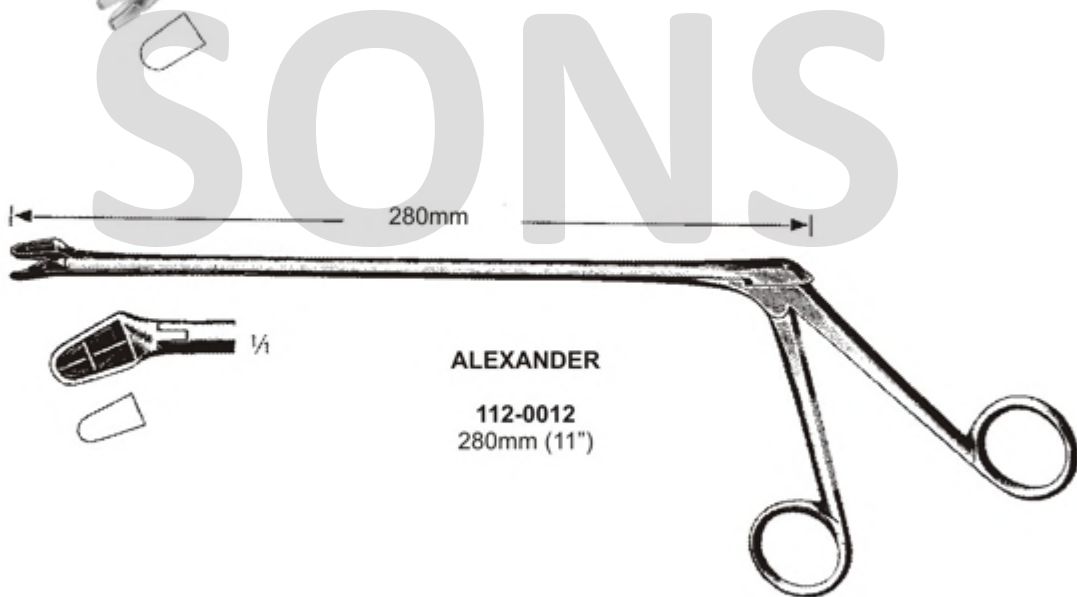
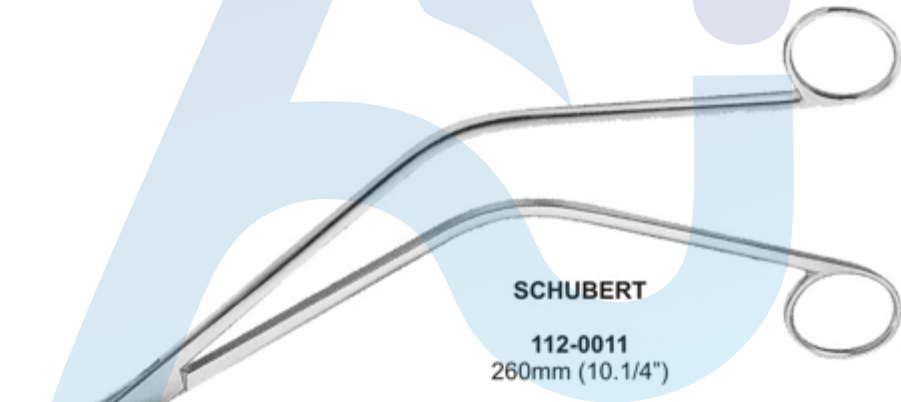
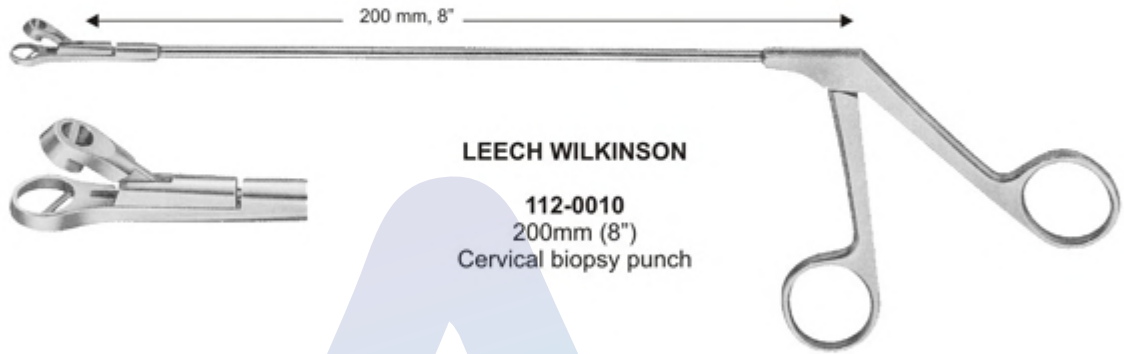

●●● Cervical Biopsy Forceps

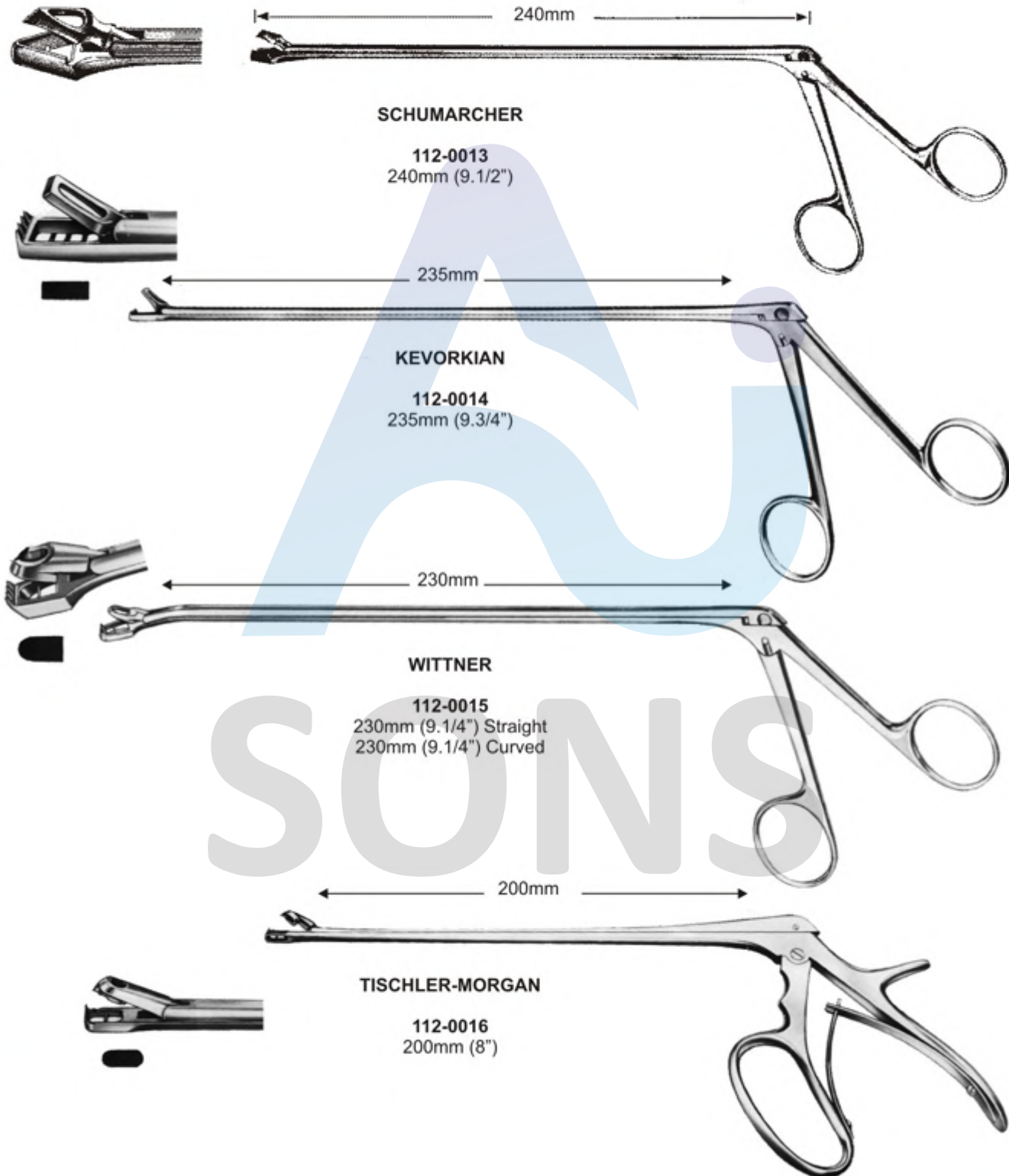

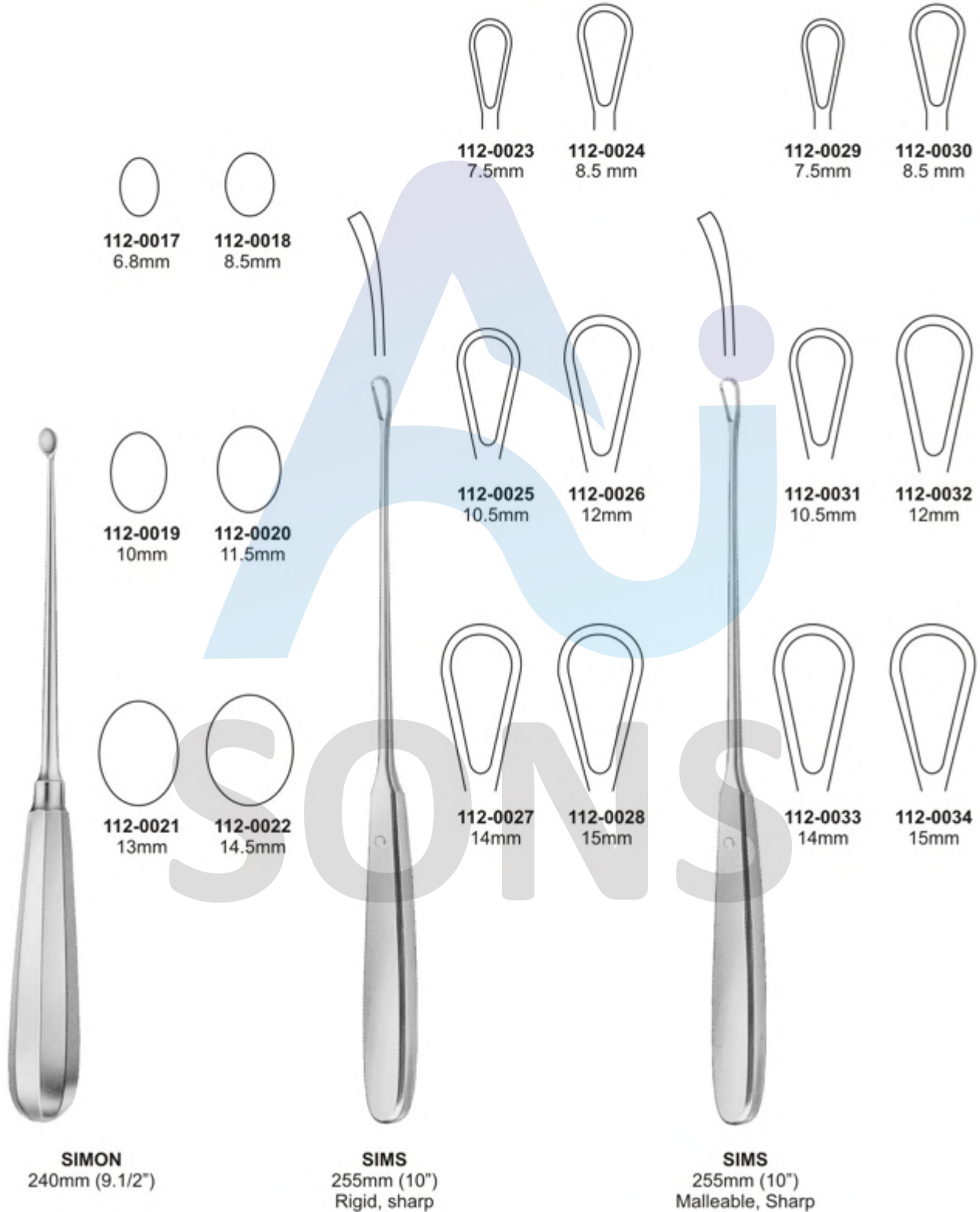

● ● ● Uterine Curettes

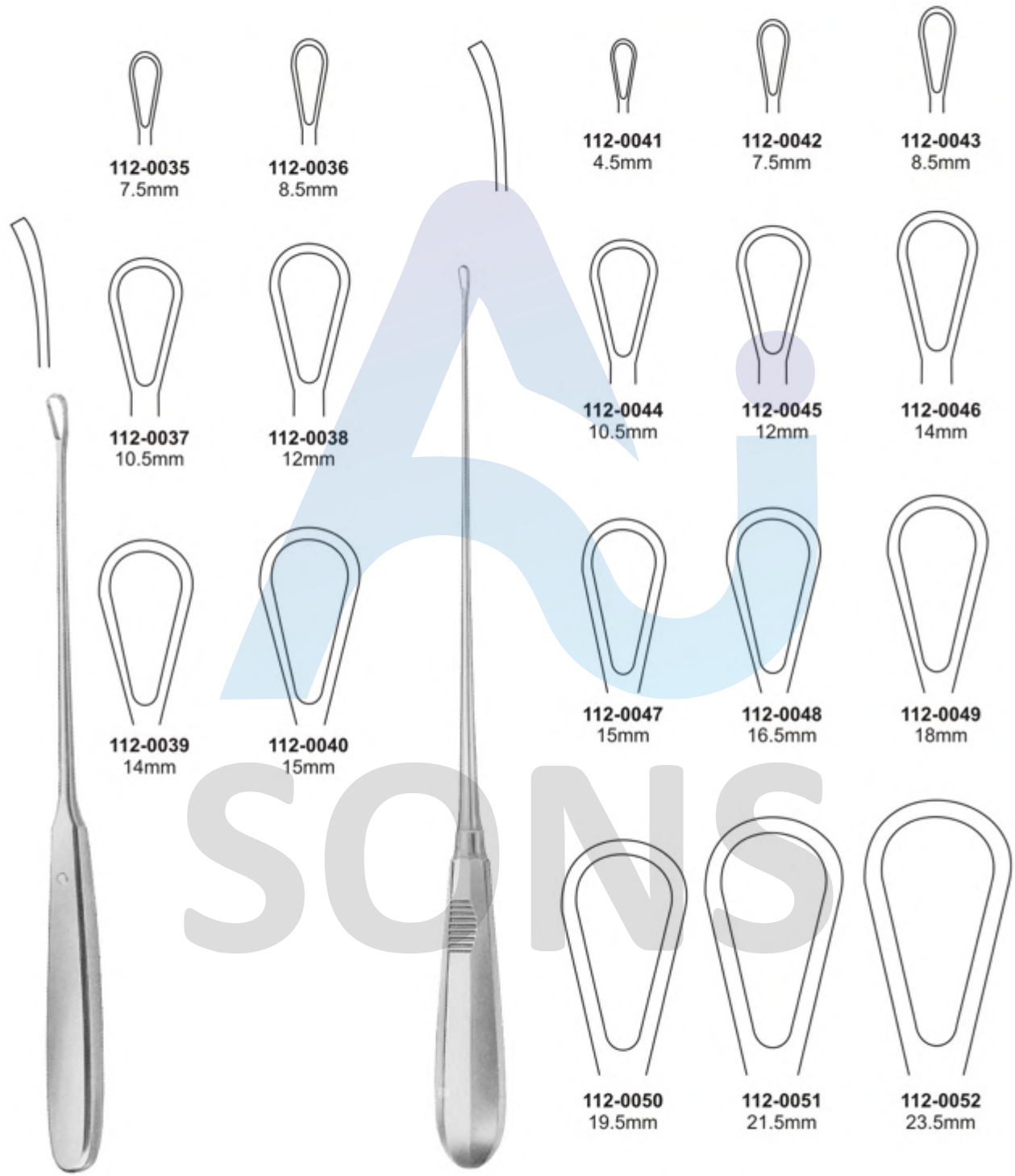

112-0035
7.5mm

112-0036
8.5mm

112-0041
4.5mm

112-0042
7.5mm

112-0043
8.5mm

112-0037
10.5mm

112-0038
12mm

112-0044
10.5mm

112-0045
12mm

112-0046
14mm

112-0039
14mm

112-0040
15mm

112-0047
15mm

112-0048
16.5mm

112-0049
18mm

112-0050
19.5mm

112-0051
21.5mm

112-0052
23.5mm

SIMS
255mm (10")
Malleable, blunt

300mm (12")
Sharp



SIMS
112-0053
280mm (11")



RECAMIER
112-0054
310mm (13")



BUMM
112-0055
280mm (11")

●●● Obstetrics Instruments



SIMPSON
112-0056 300mm
(12")



SIMPSON-BRAUN
112-0057 330mm
(13")



De LEE
112-0058 300mm
(12")

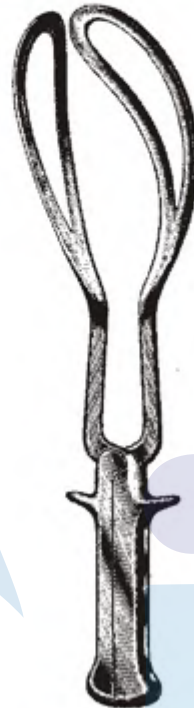

De LEE
112-0059 360mm
(14.1/2")



ELLIOT
112-0060 320mm
(12.1/2")



NAEGELE
112-0061
360mm (14.1/2")



I.U.D. REMOVING HOOK
112-0062 320mm (12.1/2")



WRIGLEY
112-0063 250mm (10")



KIELLAND
112-0064 402mm (16.3/4")



LUIKART

112-0065
400mm (16")



KIELLAND-LUIKART

112-0066
400mm (16")



SIMPSON-LUIKART

112-0067
360mm (14.1/2")



McLEAN-TUCKER-LUIKART

112-0068
400mm (16")



McLEAN-TUCKER

112-0069
390mm (15.1/2")



McLEAN-LUIKART

112-0070
390mm (15.1/2")



McLEAN

112-0071
360mm (14.1/2")



BARTON

112-0072
360mm (14.1/2")



BARTON

112-0073
170mm (6.3/4")

●●● Dermatology, Gynecology Instruments



**GREEN - ARMYTAGE
HEAMOSTASIS FORCEPS**
113-0001
200mm (8") Straight
113-0002
195mm (7.3/4") Angled



WINTER OVUM FORCEPS
290mm (11.1/2")



113-0003



113-0004



113-0005



SAENGER OVUM FORCEPS
113-0006
275mm (10.3/4")



UMBILICAL DILATOR
113-0007
95mm (3.3/4")



113-0008

113-0009

MIKULICZ
113-0008 180mm (7")
113-0009 205mm (8")

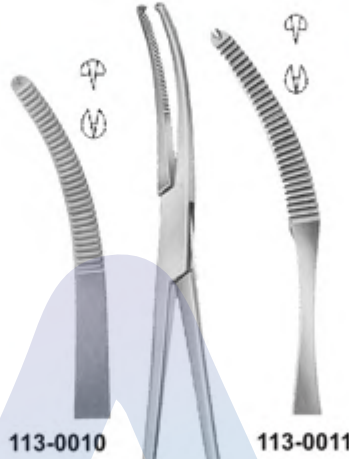

113-0010

113-0011

PEROTONEUM
113-0010 205mm (8")
113-0011 205mm (8")



113-0012

113-0013

FAURE
113-0012 205mm (8")
113-0013 205mm (8")



113-0014

113-0015

GWILLIAM
HYSTERECTOMY 200mm (8")
113-0014 Straight
113-0015 Curved



113-0016

HEANY
HYSTERECTOMY FORCEPS 200m (8")
113-0016 Curved, single tooth



113-0017

113-0018

HEANY
113-0017 205mm (8")
113-0018 245cm (9.3/4")

●●● Hysterectomy Clamps



**MAINGOT
GYSTERECTOMY FORCEPS**
113-0019 200mm (8")
 Curved, 1 x 2 teeth
113-0020
 Straight, 1 x 2 teeth
113-0021 240mm (9.1/2")
 Curved, 1 x 2 teeth

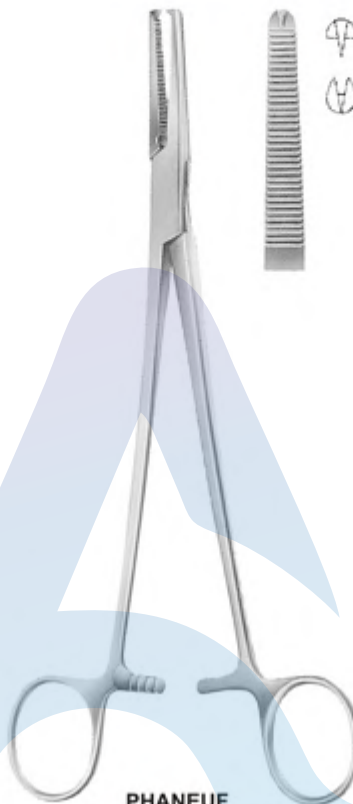

PHANEUF
113-0022 205mm (8")
 Straight, 1 x 2 teeth



BONNEY
113-0023 205mm (8")
 Angled on flat, 1 x 2 teeth



**HYSTERECTOMY
FORCEPS**
 Atraumatic



113-0024
 215mm (8.1/2")

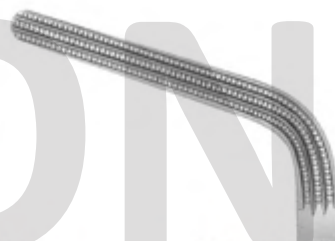

113-0025
 205mm (8")



113-0026
 220mm (8.3/4")



113-0027
 240mm (9.1/2")



113-0028
 225mm (9")



113-0029
 250mm (10")



113-0030
 245mm (9.3/4")



113-0031
 230mm (9")

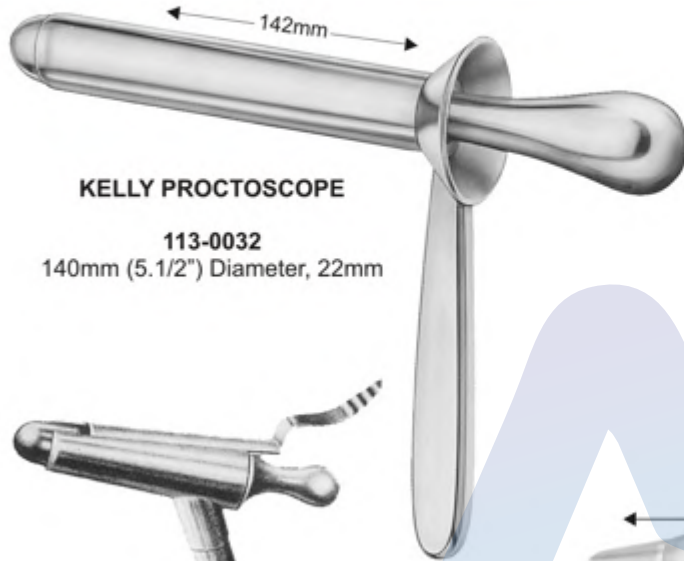

KELLY PROCTOSCOPE
113-0032
140mm (5.1/2") Diameter, 22mm

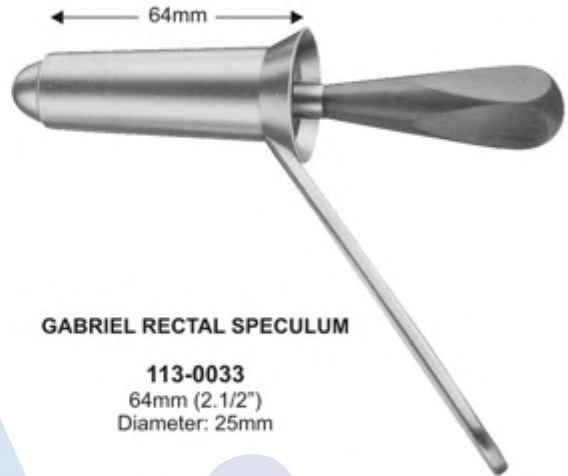

GABRIEL RECTAL SPECULUM
113-0033
64mm (2.1/2")
Diameter: 25mm



MCEVEDY RECTAL SPECULUM WITH BATTERY HANDLE
113-0034 150mm (6")
Diameter: 27mm

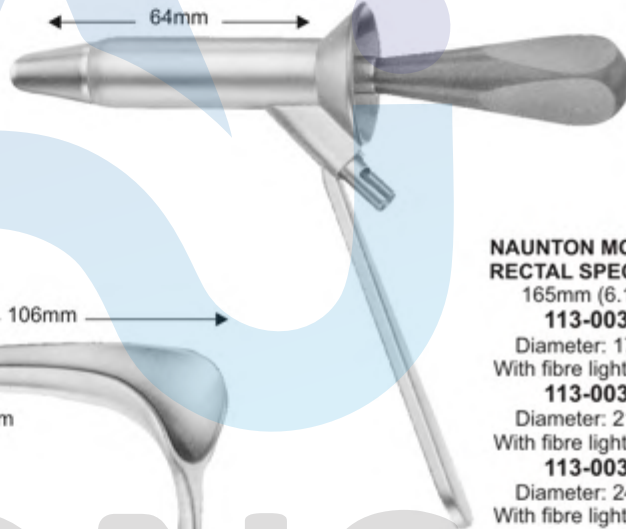

NAUNTUN MORGAN RECTAL SPECULUM
165mm (6.1/2")
113-0035
Diameter: 17mm
With fibre light carrier
113-0036
Diameter: 21mm
With fibre light carrier
113-0037
Diameter: 24mm
With fibre light carrier



PRATT RECTAL SPECULUM
113-0038
205mm (8")



CZERNY RECTAL SPECULUM
113-0039
225mm (9")



SIMS RECTAL SPECULUM
113-0040
160mm (6.1/4")

●●● Urology



RANDALL
Renal Calculus Forceps

113-0041
A
230mm (9")



113-0042
B
200mm (8")



113-0043
C
195mm (7.3/4")



113-0044
D
180mm (7")



MILLIN
113-0045
245mm (9.3/4")
Ligature holding forceps



BLADDER SPATULA
113-0046 235mm (9.3/4")
Blade: 91mm x 61mm



GUYON
113-0047 265mm (10.1/2")



KIDNEY CLAMP
113-0048 255mm (10")

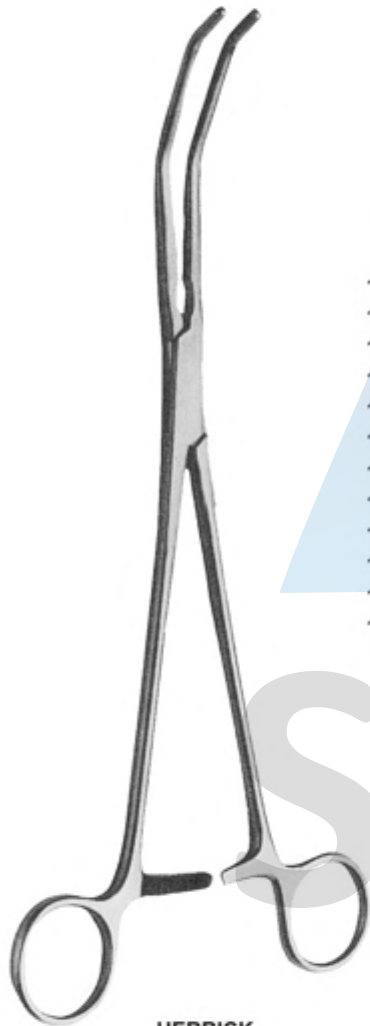

HERRICK
113-0049 225mm (9")

113-0050	6/10 f.g (2/3.33mm)
113-0051	8/12 f.g (2.66/4.66mm)
113-0052	10/14 f.g (3.33/4.66mm)
113-0053	12/16 f.g (4/5.33mm)
113-0054	14/18 f.g (4.66/6mm)
113-0055	16/20 f.g (5.33/6.66mm)
113-0056	18/22 f.g (6/7.33mm)
113-0057	20/24 f.g (6.66/8mm)
113-0058	22/26 f.g (7.33/8.66mm)
113-0059	24/28 f.g (8/9.33mm)
113-0060	26/30 f.g (8.66/33mm)
113-0061	28/32 f.g (9.33/10.66mm)

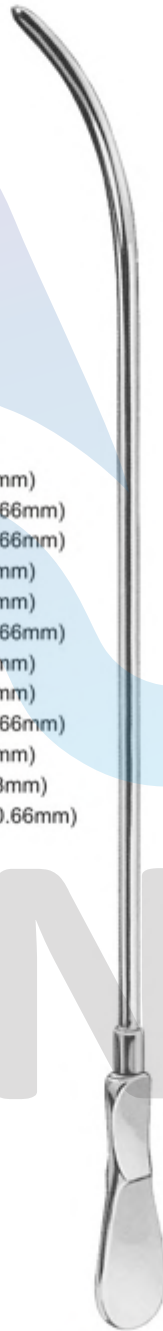

CLUTTON URETHRAL SOUNDS
265mm (10.1/2")
Set twelve **113-0062**
Set Comprising one of each of:



FEMALE CATHETERS
160mm (6.1/4")

113-0062	12 f.g (4mm)
113-0063	8 f.g (2.66mm)
113-0064	10 f.g (3.33mm)
113-0065	14 f.g (4.66mm)
113-0066	16 f.g (5.33mm)

●●● Suction Tubes



POOLE

113-0069
240mm (9.1/2")

113-0070
180mm (7")
Lawrie extension piece

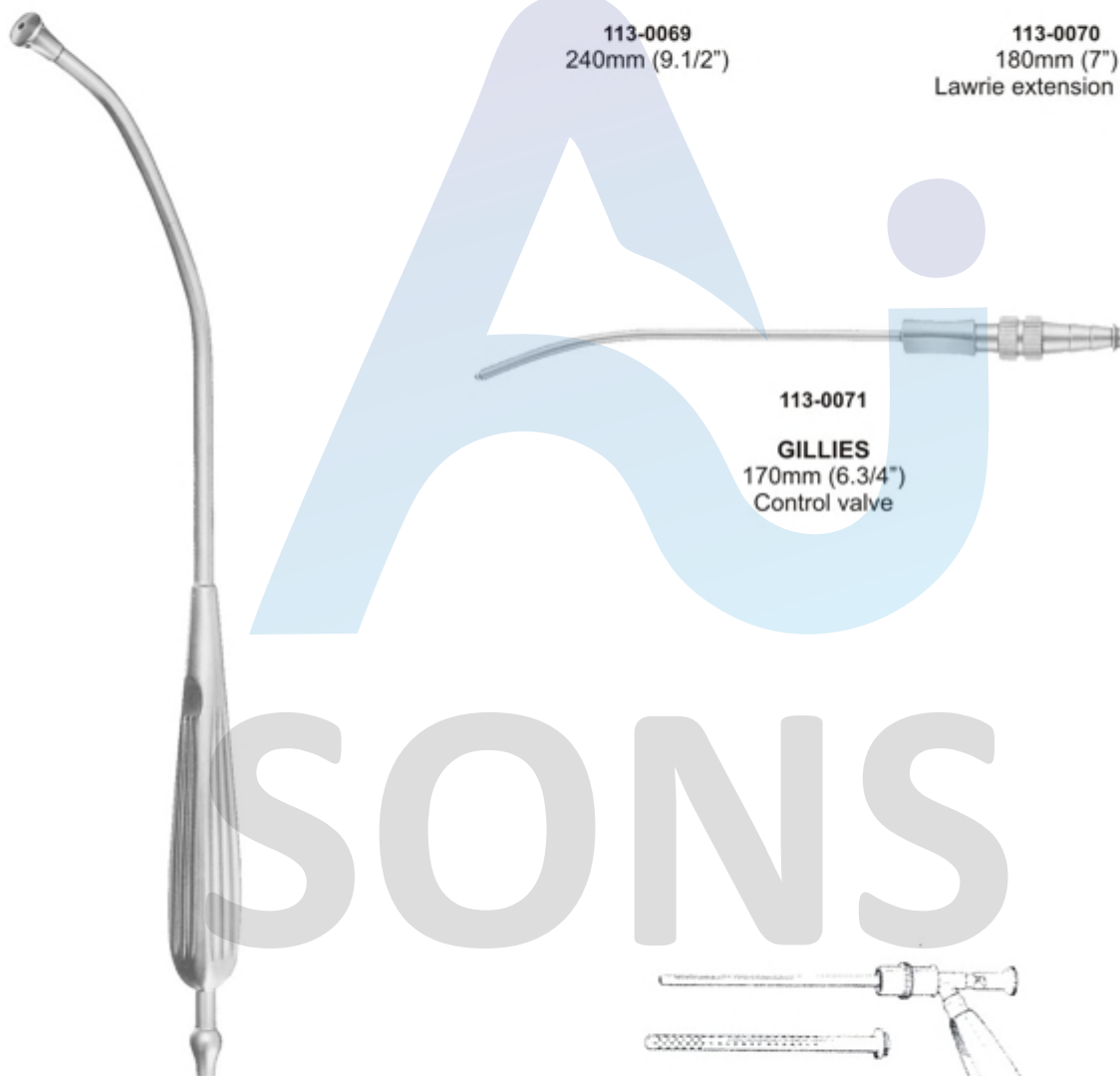

113-0071
GILLIES
170mm (6.3/4")
Control valve

YANKAUER

113-0067
305mm (12")

113-0068
Rose end

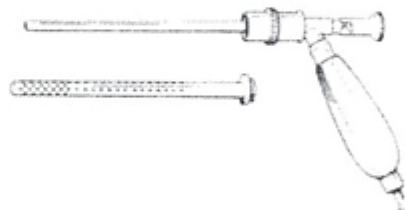

TINCKLER
(SIMPSON SMITH)

113-0072
255mm (10")

With on / off value, removable perforated outer sheath

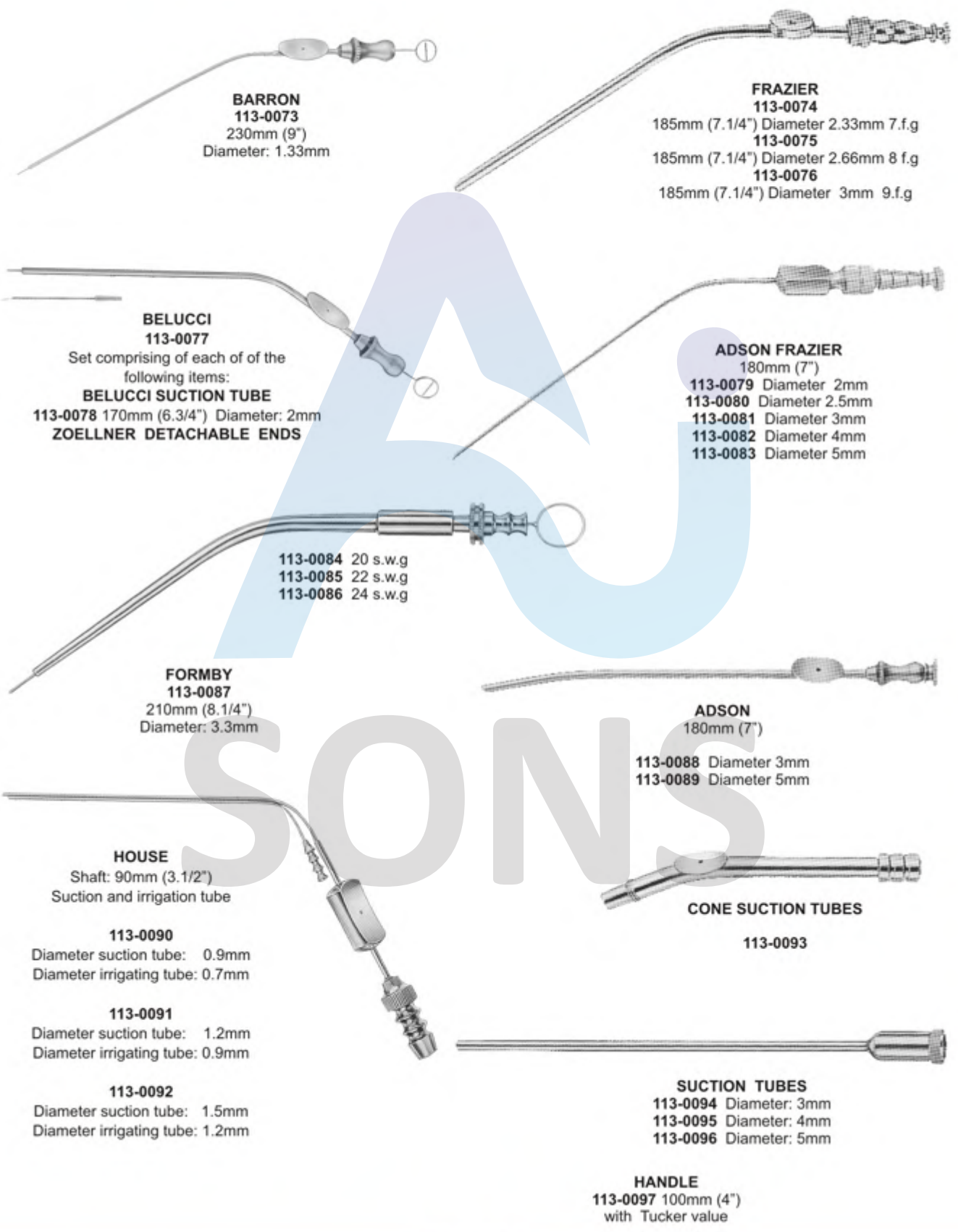

BARRON
113-0073
230mm (9")
Diameter: 1.33mm

FRAZIER
113-0074 Diameter 2.33mm 7.f.g
113-0075 Diameter 2.66mm 8.f.g
113-0076 Diameter 3mm 9.f.g

BELUCCI
113-0077
Set comprising of each of the following items:
BELUCCI SUCTION TUBE
113-0078 170mm (6.3/4") Diameter: 2mm
ZOELLNER DETACHABLE ENDS

ADSON FRAZIER
180mm (7")
113-0079 Diameter 2mm
113-0080 Diameter 2.5mm
113-0081 Diameter 3mm
113-0082 Diameter 4mm
113-0083 Diameter 5mm

113-0084 20 s.w.g
113-0085 22 s.w.g
113-0086 24 s.w.g

FORMBY
113-0087
210mm (8.1/4")
Diameter: 3.3mm

ADSON
180mm (7")
113-0088 Diameter 3mm
113-0089 Diameter 5mm

HOUSE
Shaft: 90mm (3.1/2")
Suction and irrigating tube

CONE SUCTION TUBES
113-0093

113-0090
Diameter suction tube: 0.9mm
Diameter irrigating tube: 0.7mm

113-0091
Diameter suction tube: 1.2mm
Diameter irrigating tube: 0.9mm

113-0092
Diameter suction tube: 1.5mm
Diameter irrigating tube: 1.2mm

SUCTION TUBES
113-0094 Diameter: 3mm
113-0095 Diameter: 4mm
113-0096 Diameter: 5mm

HANDLE
113-0097 100mm (4")
with Tucker valve

●●● Amputation Instruments



**PERCY AMPUTATION FLAP
RETRACTOR**

114-0001
Removable handles



AMPUTATION SAW
With hinged back
to take apart

114-0002
Blade: 230mm (9")

114-0003
Spare blade for
amputation saw



FINGER SAW

114-0004
200mm (8")



**ARMY REGULATION
AMPUTATION SAW**

114-0005
Blade: 180mm (7")
With hinged back
to take apart

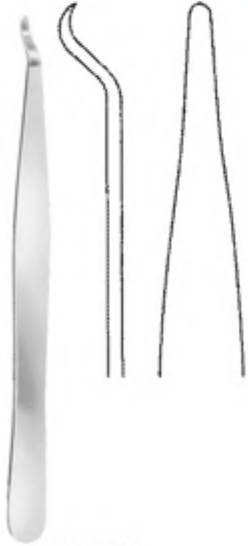

115-0001
140mm (5.1/2")
Width at tip 2.8mm

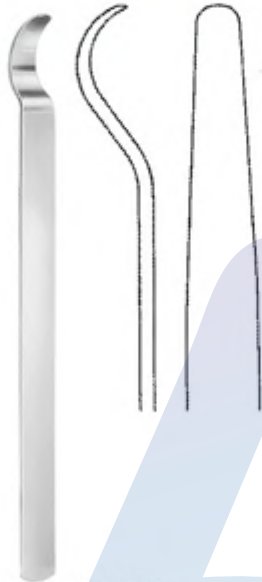

115-0002
150mm (6")
Width at tip 6mm

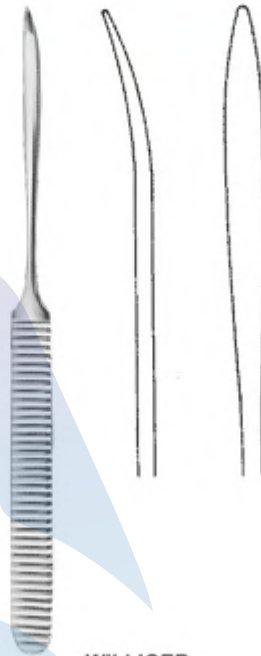

WILLIGER
115-0003
175mm (7")
Width at tip 5.5mm



WILLIGER
115-0004
160mm (6.1/4")
Width at tip 6.5mm

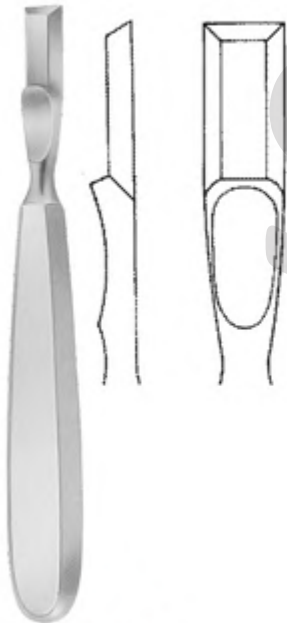

FARABEU
160mm (6.1/4")
8mm wide
115-0005 Straight
115-0006 Curved



HOWARTH
115-0007 230mm (9")

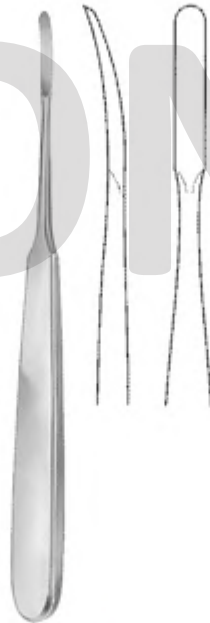

JOSEPH
115-0007
170mm (6.3/4")
Width at tip: 4mm



MACDONALD
115-0008
185mm (7.1/4") blunt

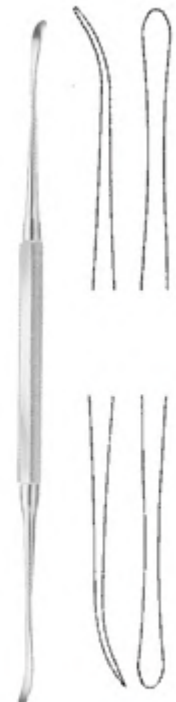

FREER ELEVATOR
115-0009
190mm (7.1/2"),
double ended

●●● Bone Levers & Raspatories



ADSON
165mm (6.1/2"), curved
115-0010 width 5mm
115-0011 width 7mm



ADSON
165mm (6.1/2") slight curve
115-0012 Width 7mm

PENNYBACKER
150mm (6")
115-0013
Width 6mm



VOLKMAN
170mm (6.3/4")

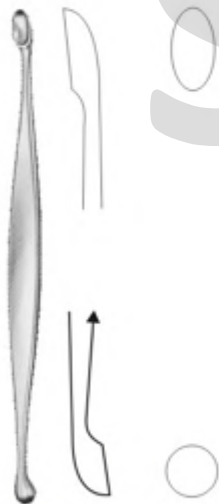
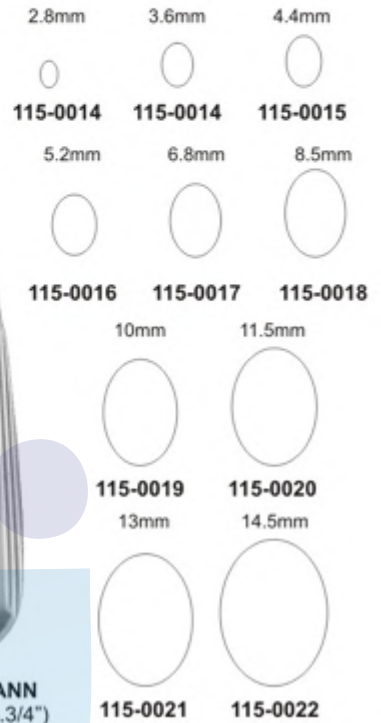

BOYD BONE CURETTE
Oval, double ended
115-0023 130mm (5.1/8")



BOYD BONE CURETTE
Oval, double ended
115-0024 160mm (6.1/4")



BOYD BONE CURETTE
Oval, double ended
115-0025 200mm (8")



VOLKMANN
Double ended
115-0026
130mm (5.1/8")
115-0027
140mm (5.1/2")
115-0028
170mm (6.3/4")



MACEWEN
180mm (7")
Combined
with seeker
115-0029
Oval
115-0030
Round

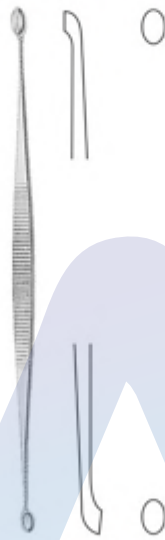

JACOBSON
115-0031
140mm (5.1/2")

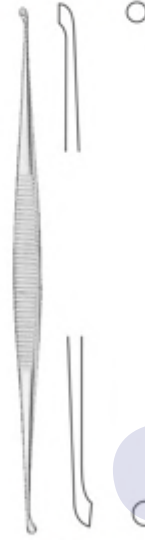

MARTINI
115-0032
140mm (5.1/2")



MARTINI
115-0033
140mm (5.1/2")

115-0034
2mm x 3.5mm

115-0040
2mm x 3mm

115-0035
2mm x 4mm

115-0036
2.5mm x 4.5mm

115-0041
3mm x 4mm

115-0037
2.75mm x 5mm

115-0042
4mm x 5mm

115-0038
3mm x 5.5mm

115-0039
3.25mm x 6mm

115-0043
5mm x 6mm



LEMPERT
200mm (8")*



COLLIER AND MORRIS
180mm (7")

●●● Mallets, Bone Holding Forceps



LUCAE
116-0001
Diameter: 27mm
8.1/2 oz

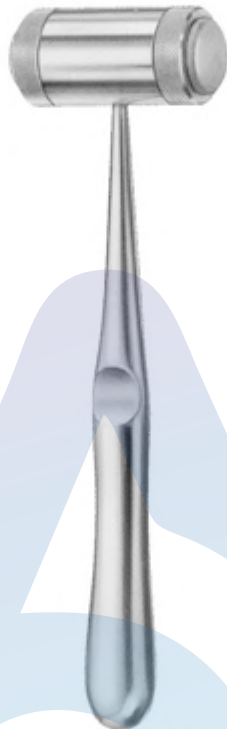

KELSEY FRY
116-0002 190mm (7.1/2")
Diameter: 20mm
SPARE DISKS
116-0003 Spare disks for
Kelsey-Fry Mallet



HEATH
116-0004
Diameter: 25mm 28 oz
116-0005
Diameter: 40mm 36 oz



**SEQUESTUM
FORCEPS**
116-0006
190mm (7.1/2")
Straight



**SEQUESTUM
FORCEPS**
116-0007
190mm (7.1/2")
Angled



FERGUSSON
116-0008
200mm (8")

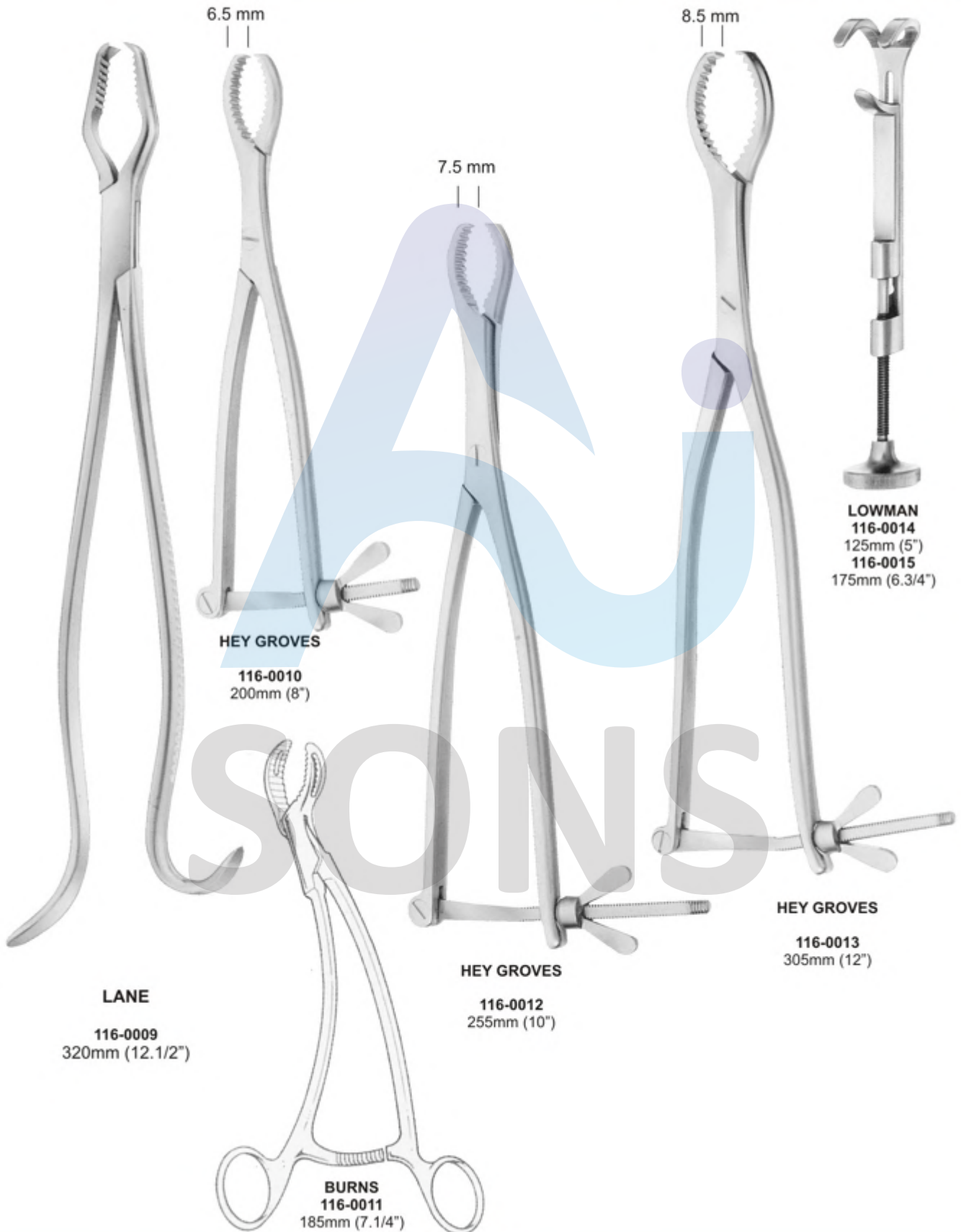

6.5 mm

8.5 mm

7.5 mm

HEY GROVES

116-0010
200mm (8")

LOWMAN
116-0014
125mm (5")
116-0015
175mm (6.3/4")

HEY GROVES

116-0013
305mm (12")

LANE

116-0009
320mm (12.1/2")

HEY GROVES

116-0012
255mm (10")

BURNS
116-0011

185mm (7.1/4")

●●● Bone Holding Forceps

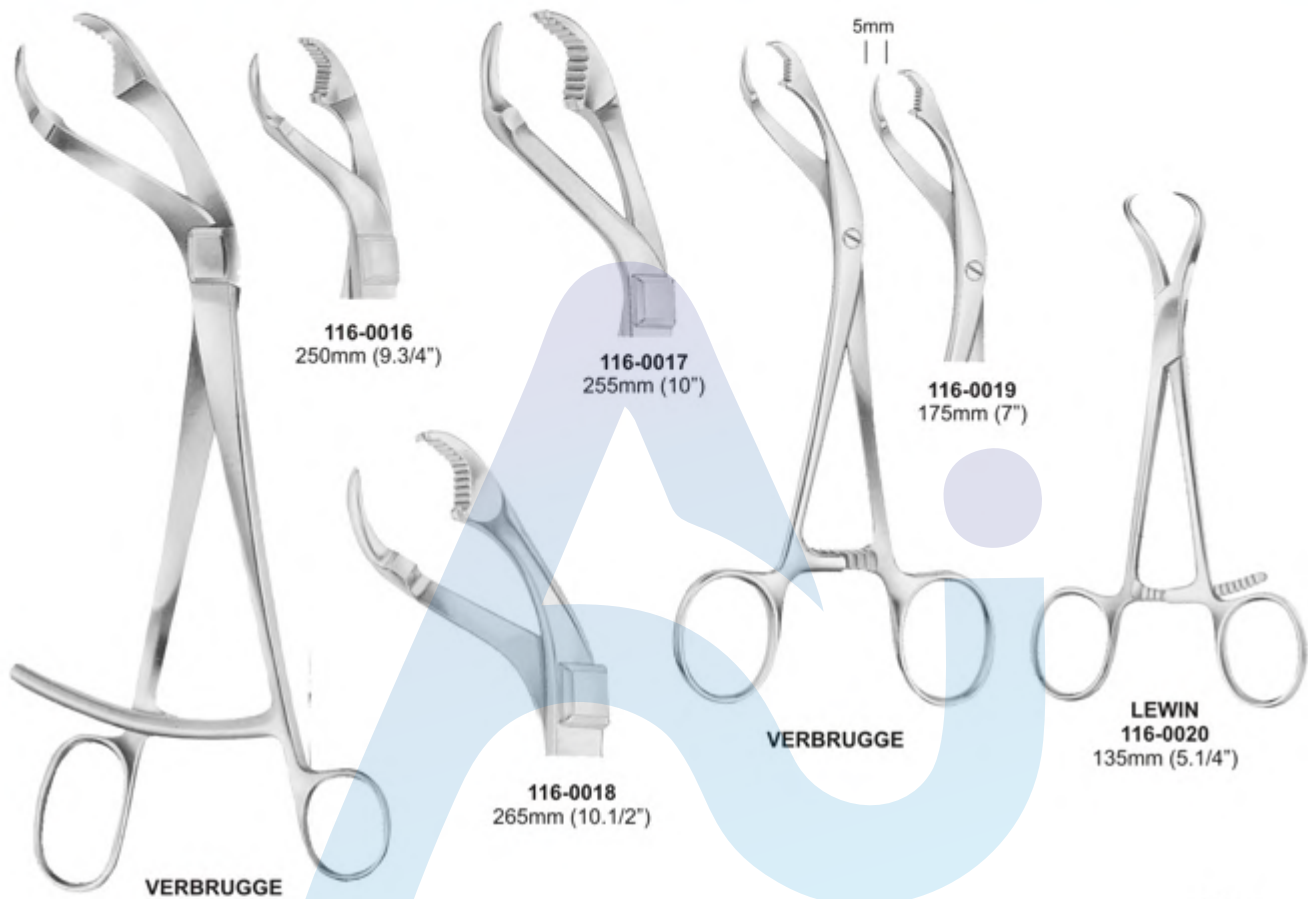

116-0016
250mm (9.3/4")

116-0017
255mm (10")

116-0019
175mm (7")

LEWIN
116-0020
135mm (5.1/4")

VERBRUGGE

116-0018
265mm (10.1/2")

VERBRUGGE

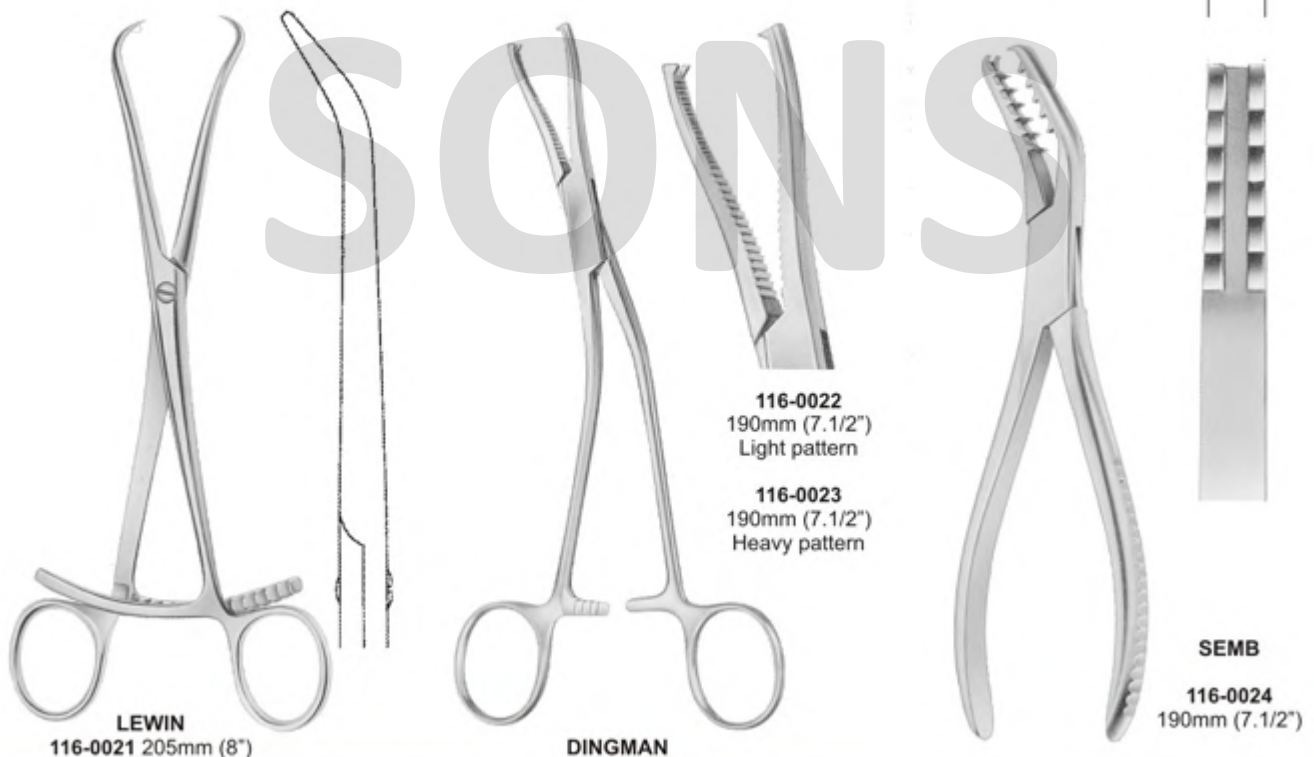

LEWIN
116-0021 205mm (8")

DINGMAN

116-0022
190mm (7.1/2")
Light pattern

116-0023
190mm (7.1/2")
Heavy pattern

SEMB
116-0024
190mm (7.1/2")



BEYER
117-0001
150mm (6")
5mm bite



JANSEN-MIDDLETON
SEPTUM FORCEPS
117-0002
200mm (8") Spoon shaped
4mm bite

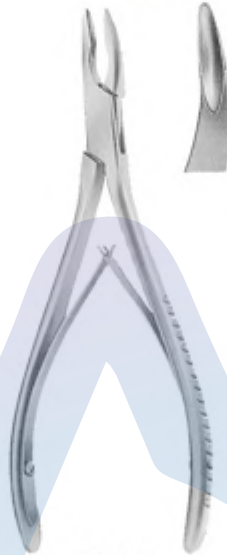

CAIRNS
117-0003
140mm (5.1/2")
4mm bite



CAIRNS
117-0004
140mm (5.1/2")
4mm bite



LUER
117-0005
155mm (6")



RUSKIN
117-0006
190mm (7.1/2")
6mm bite



HARTMANN
117-0007
180mm (7")



MEAD
117-0008
165mm (6.1/2")



JANSEN
117-0009
150mm (6")

●●● Bone Rongeurs



TROTTER
117-0010
200mm (8")
10mm bite



SYNOVECTOMY RONGEUR
117-0011
175mm (7")



HEANLEY
117-0012
175mm (7")
4mm bite

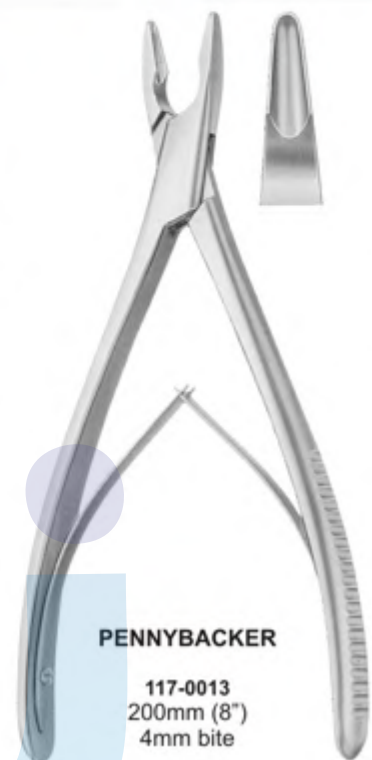

PENNYBACKER
117-0013
200mm (8")
4mm bite



SYNOVECTOMY RONGEUR
117-0014
130mm (5.1/8")
Jaw width 2mm



NORTHFIELD
117-0015
200mm (8")
10mm bite



WILMS
117-0016
200mm (8")
4mm bite



LEKSELL
117-0017
240mm (9.1/2")
6mm bite
117-0018
240mm (9.1/2")
8mm bite

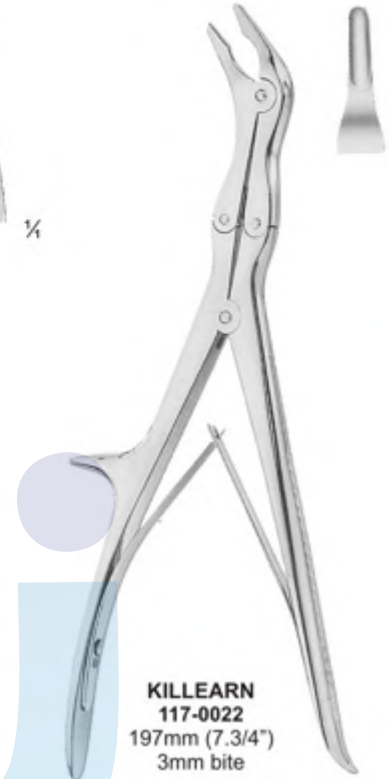

●●● Bone Rongeurs



SARGENT (VAN HAVRE)
117-0026
220mm (8.3/4")
10mm bite

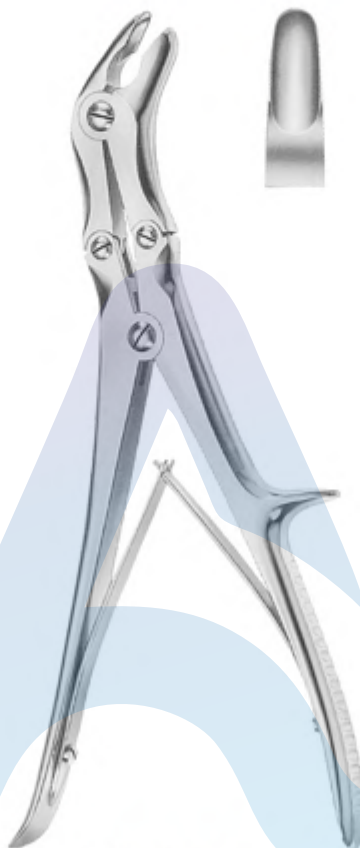

OLIVECRONA
117-0027
230mm (9")
6mm bite

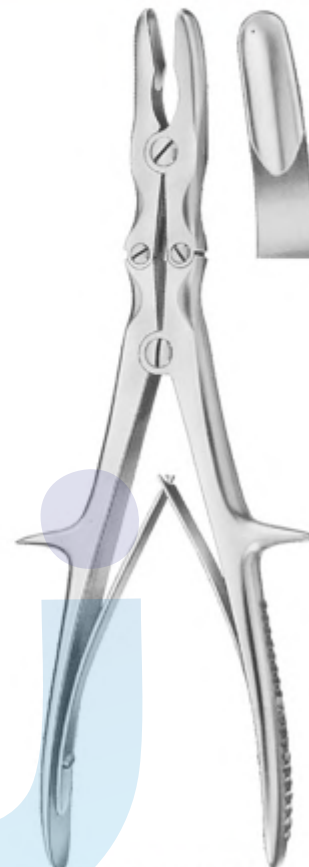

STILLE-RUSKIN
117-0028
240mm (9.1/2")

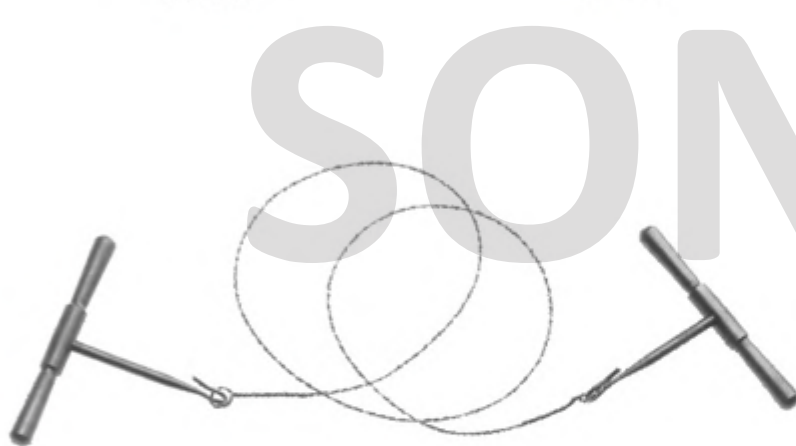

GIGLI SAW WITH HANDLE

117-0029
500mm (20")



RUDOR EDWARDS COSTOTOME

117-0030
230mm (9")

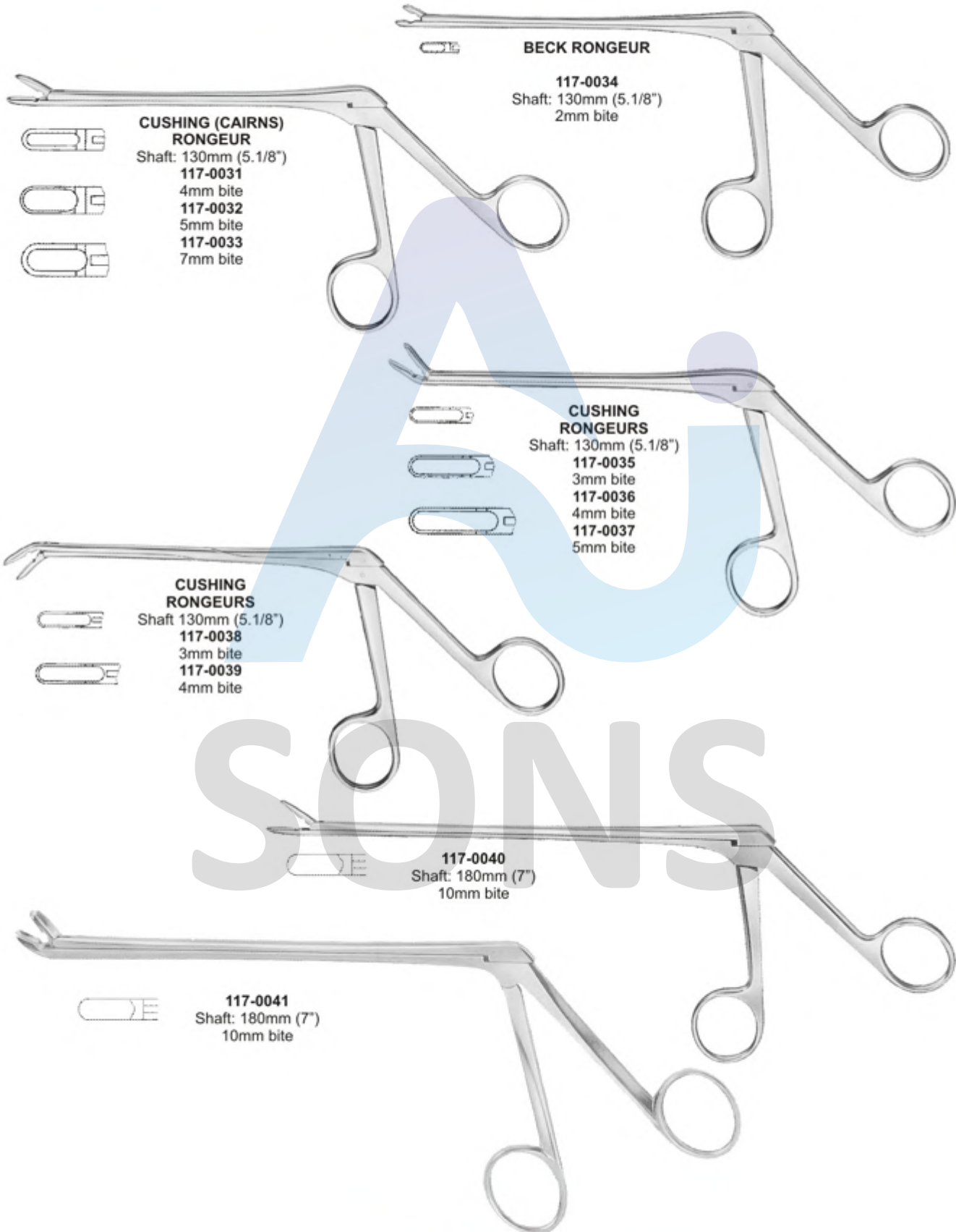

●●● Bone Cutting Forceps

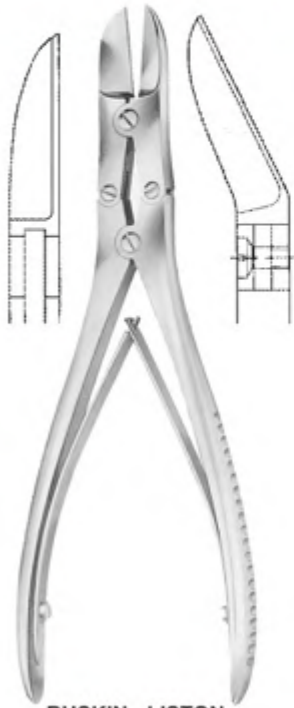

RUSKIN - LISTON
 117-0042 190mm (7.1/2")
 Straight
 117-0043 190mm (7.1/2")
 Angled on flat

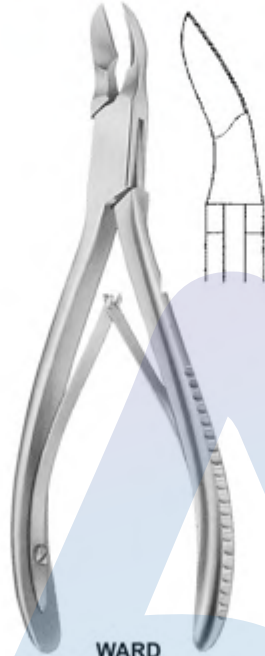

WARD
 117-0044
 170mm (6.3/4")



117-0045
 145mm (5.3/4")



117-0046
 150mm (6")



DE VILBISS
 117-0047
 210mm (8.1/4")



**LISTON
 (TUDOR EDWARDS)**
 117-0048
 265mm (10.1/2")

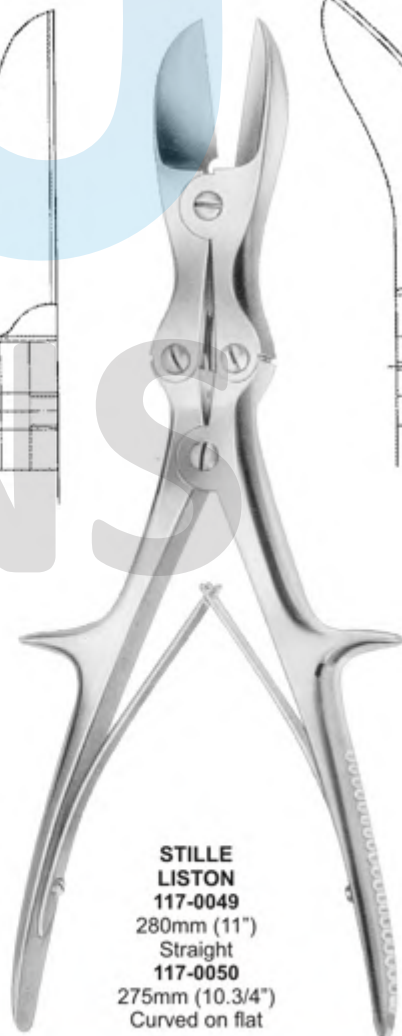

**STILLE
 LISTON**
 117-0049
 280mm (11")
 Straight
 117-0050
 275mm (10.3/4")
 Curved on flat



PLASTER SHEARS

118-0001
160mm (6.1/4")

PLASTER SHEARS

118-0002
200mm (8")

118-0003
230mm (9")

PLASTER SHEARS

118-0004
235mm (9.1/4")

●●● Rib Spreaders

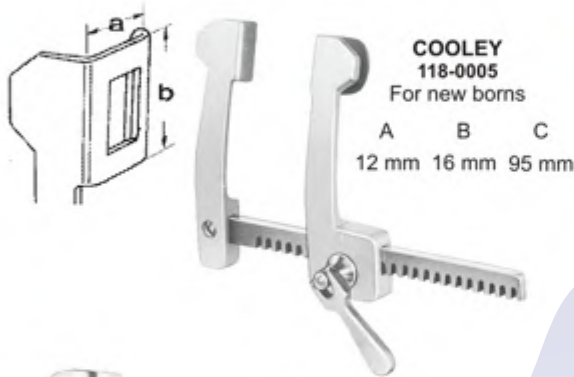

COOLEY
118-0005
For new borns

A	B	C
12 mm	16 mm	95 mm

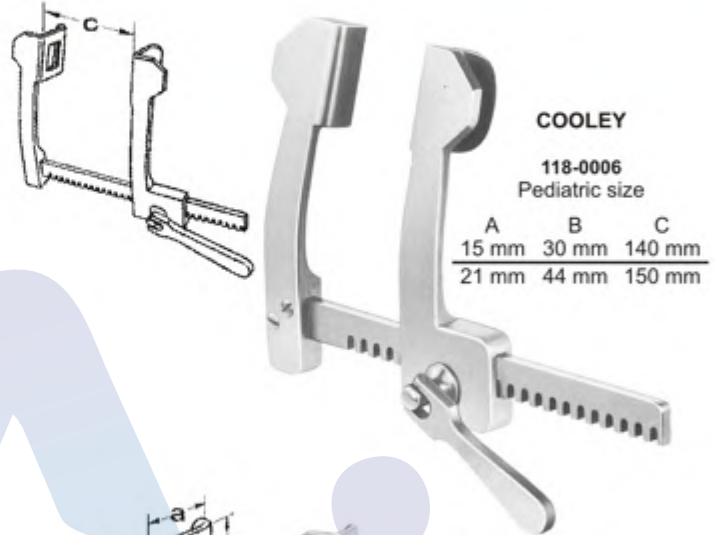

COOLEY
118-0006
Pediatric size

A	B	C
15 mm	30 mm	140 mm
21 mm	44 mm	150 mm

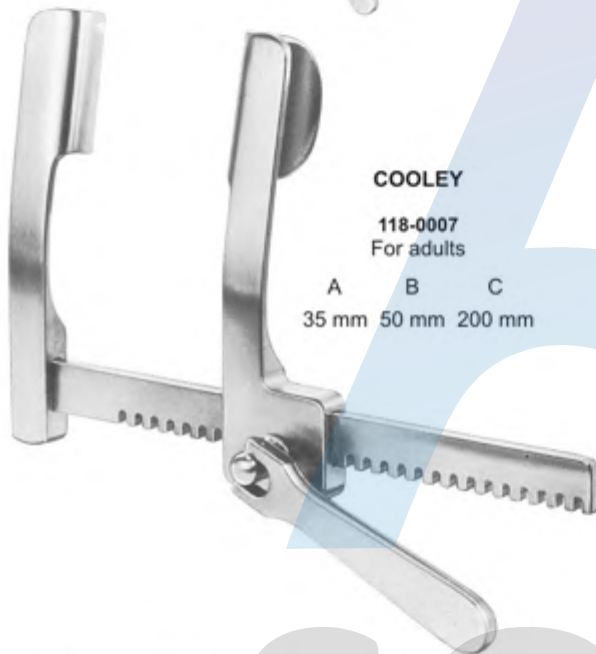

COOLEY
118-0007
For adults

A	B	C
35 mm	50 mm	200 mm

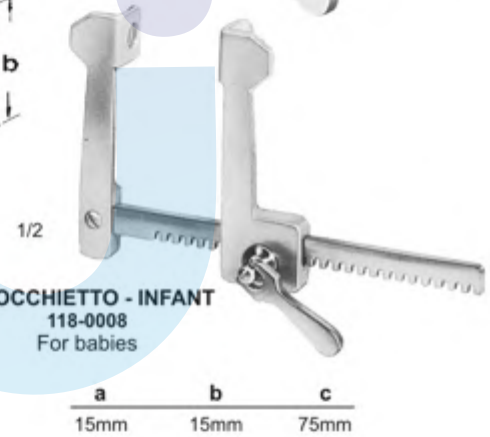

FINOCCHIETTO - INFANT
118-0008
For babies

a	b	c
15mm	15mm	75mm

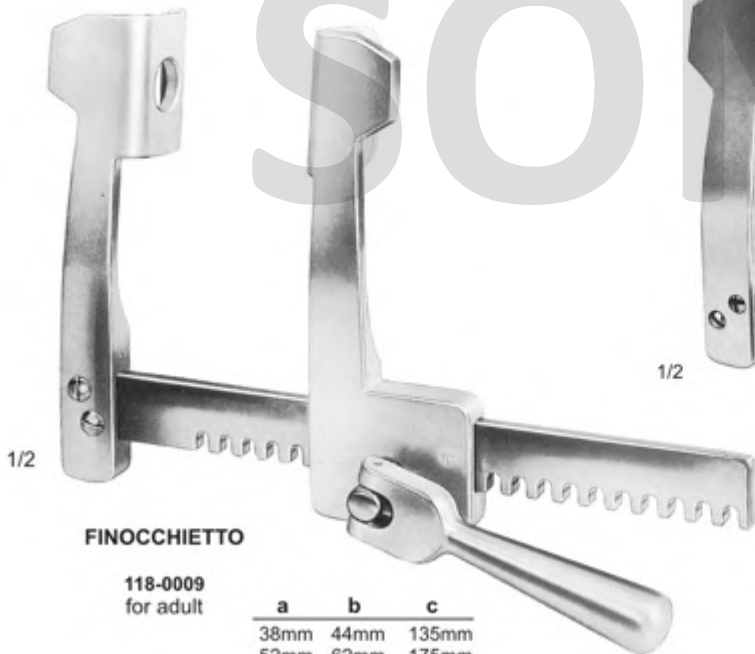

FINOCCHIETTO
118-0009
for adult

a	b	c
38mm	44mm	135mm
52mm	62mm	175mm
85mm	65mm	175mm

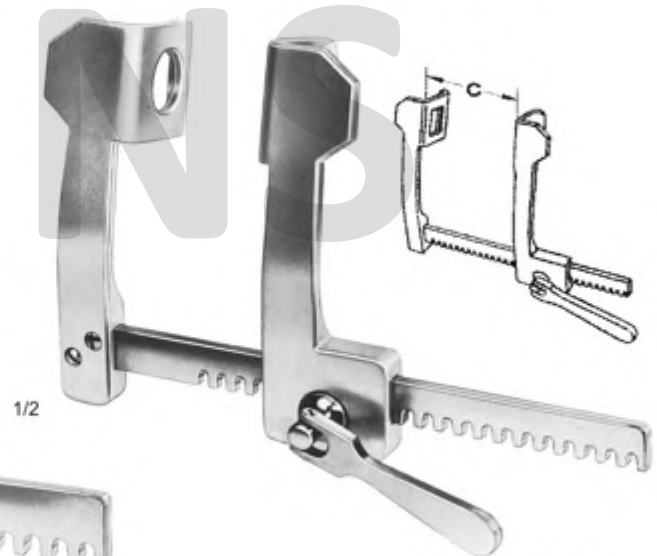

FINOCCHIETTO-BABY
118-0010
Child size

a	b	c
31mm	31mm	100mm

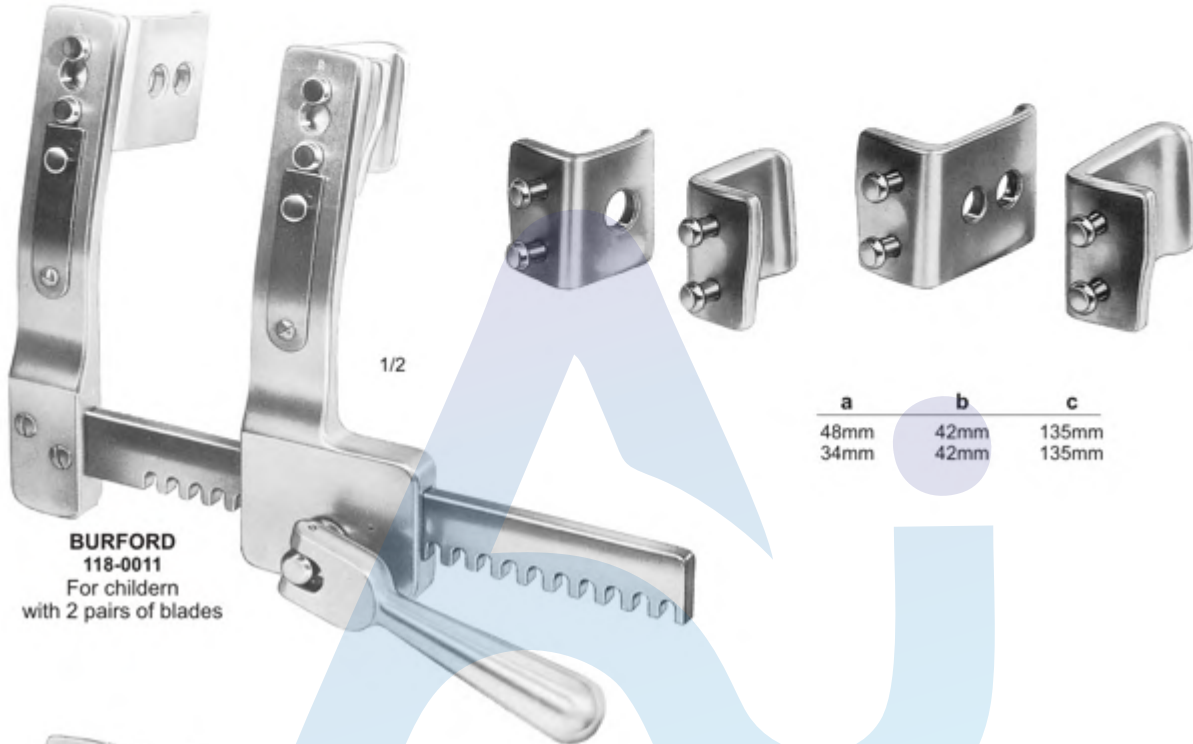

BURFORD
118-0011
For children
with 2 pairs of blades

1/2

a	b	c
48mm	42mm	135mm
34mm	42mm	135mm



BURFORD
118-0012
for adults
with pairs of blades

1/2

a	b	c
64mm	62mm	180mm
47mm	62mm	
65mm	62mm	260mm
47mm	62mm	
65mm	62mm	300mm
47mm	62mm	

●●● Bronchus, Ligature, Tissue & Organ Holding Forceps

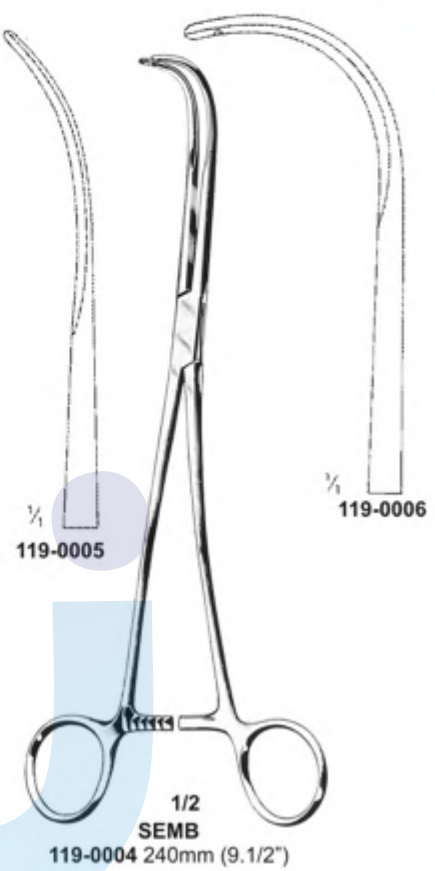
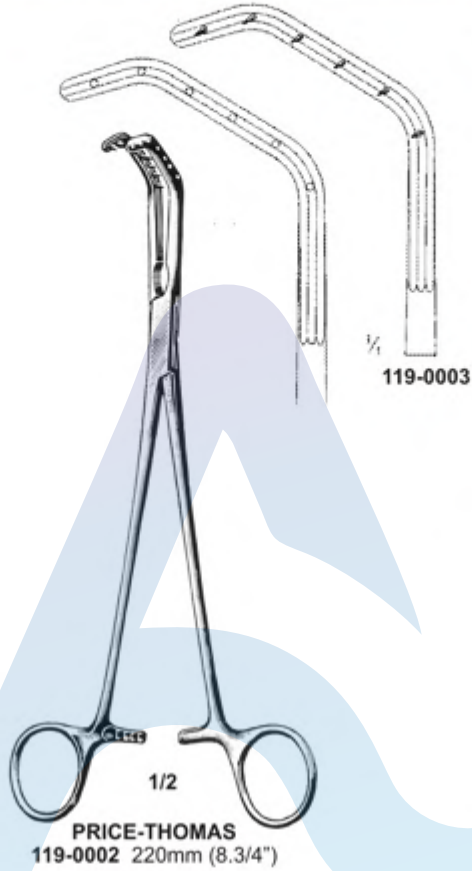

LOVELACE
Straight
119-0007
200mm (8")

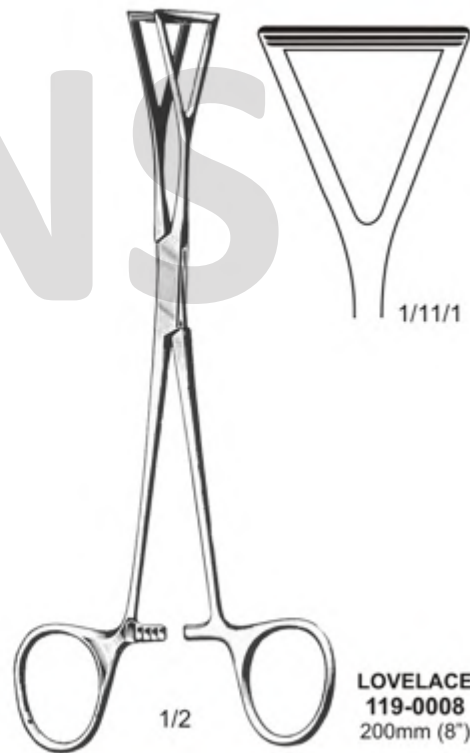

LOVELACE
119-0008
200mm (8")

Atrauma Bulldog Clamps ●●●



DE-BAKEY SATINSKY
119-0009 70mm (2.3/4")



DE BAKEY-CAROTIS
119-0010 90mm (3.1/2")



DE BAKEY SATINSKY
119-0011 100mm (4")



119-0012

GREGORY-SOFT

119-0012
90mm (3/12")

119-0014
110mm (4.1/2")



119-0013



DEBAKEY BULLDOG CLAMPS

119-0014
75mm (3")



119-0015
85mm (3.1/2")



119-0016
105mm (4.1/4")



119-0017
120mm (4.3/4")



DEBAKEY BULLDOG CLAMPS

119-0018
70mm (2.3/4")

119-0019
80mm (3.1/4")



119-0020
100mm (4")



119-0021
115mm (4.3/4")

●●● Atrauma Hemostatic, Cardiovascular Forceps

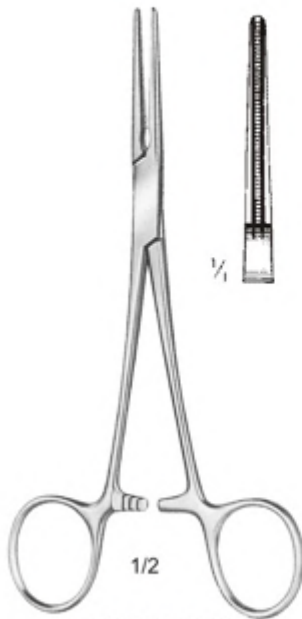

DE BAKY-RANKIN
120-0001
Straight 160mm (6.1/4")
120-0002
Curved 160mm (6.1/4")



DE BAKY-MOSQUITO
120-0003
Straight 150mm (6")
Curved 150mm (6")



OCHSNER
120-0004
235mm (9.1/4")



DIETRICH
120-0005
210mm (8.1/4")

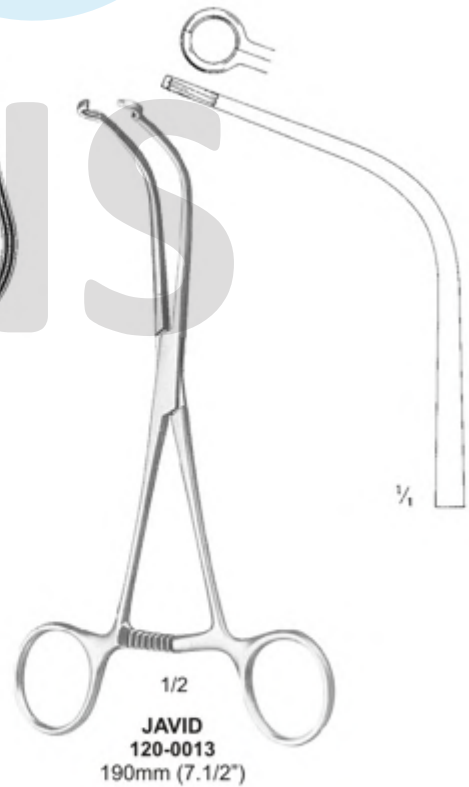
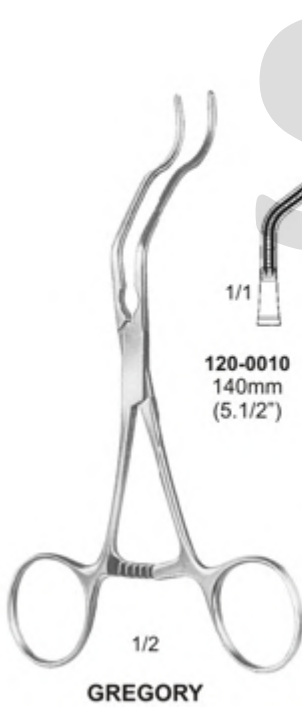
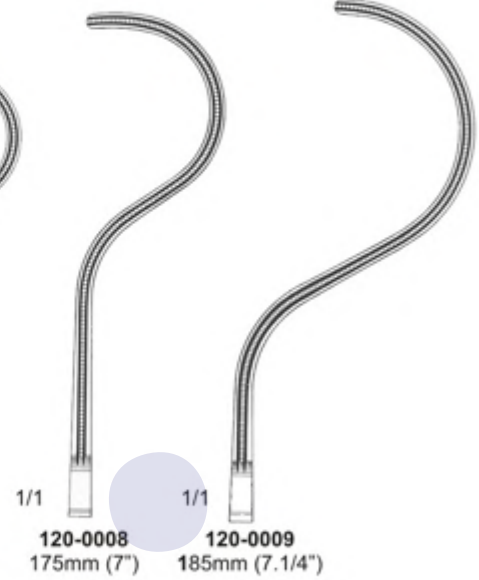
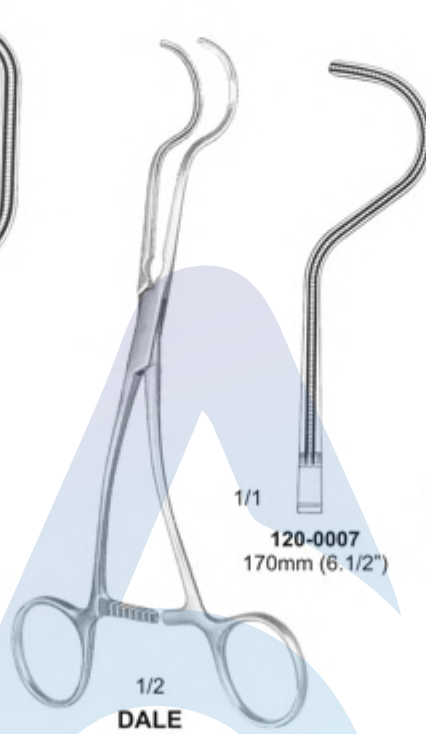

●●● Atrauma Cardiovascular Forceps

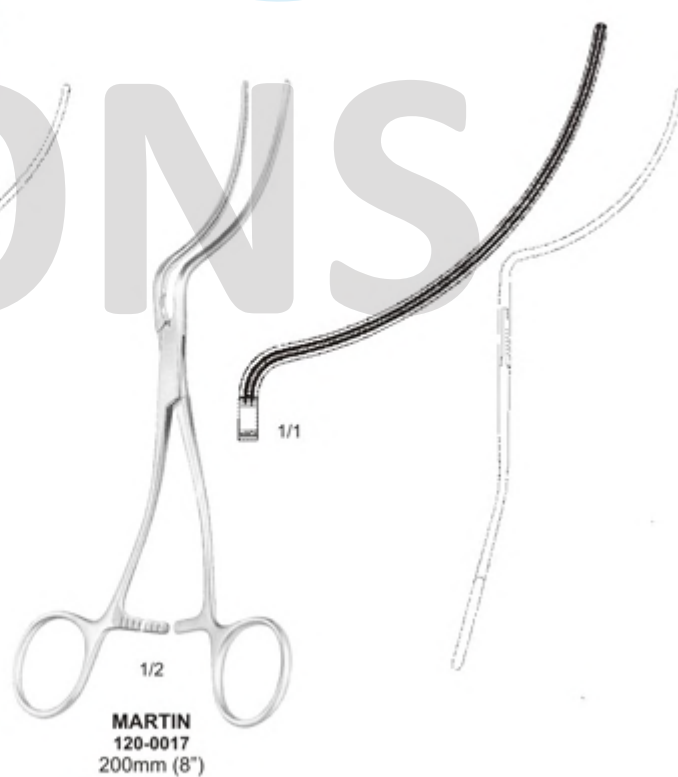
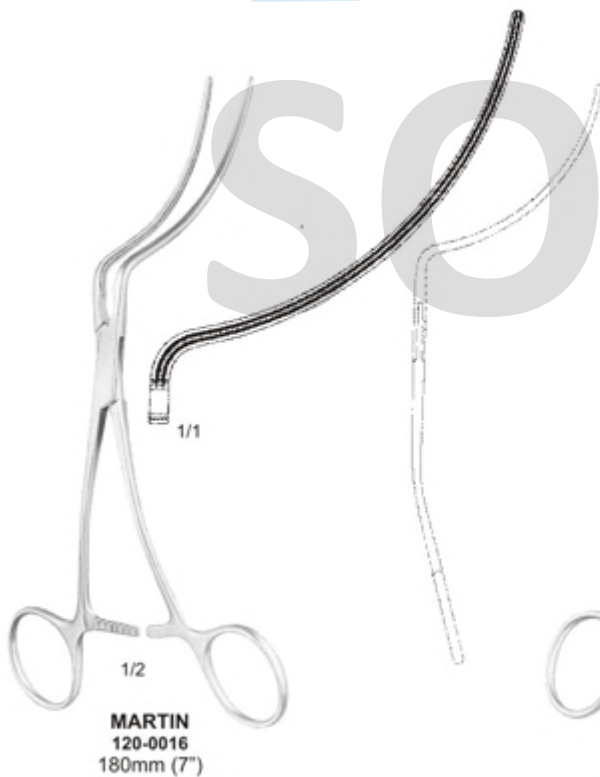
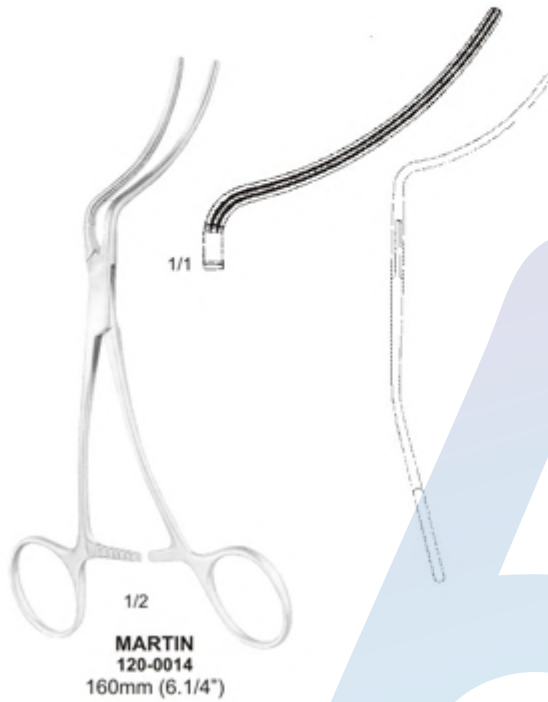

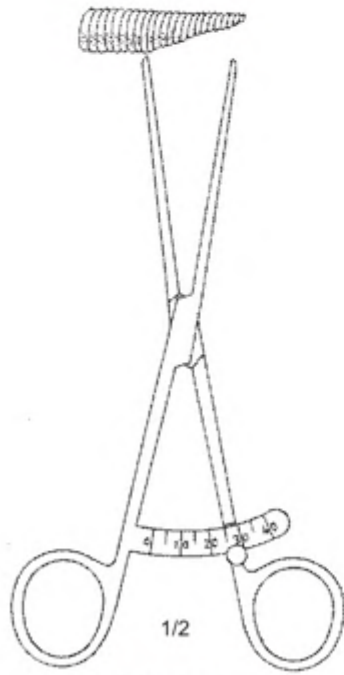

MEASURING FORCEPS

120-0018
Straight - 180mm (7")

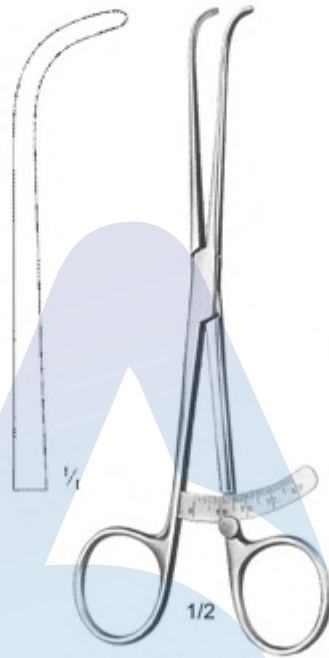

MEASURING FORCEPS

120-0019
Straight - 180mm (7")

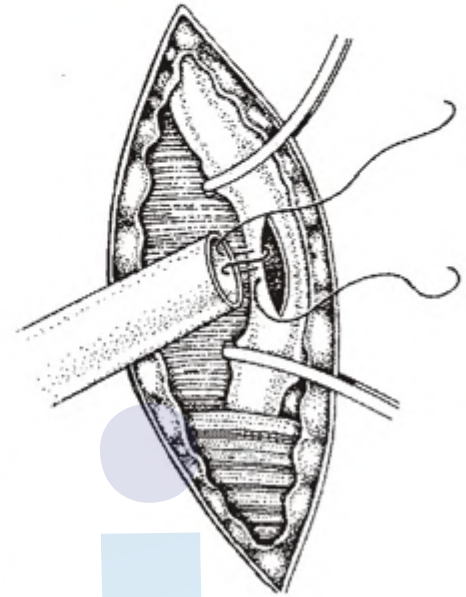

SONS

Cooley type caval occlusion used during cardiopulmonary By-Pass for occluding the vena caval. The tips of the instrument permit flow indwelling cannula

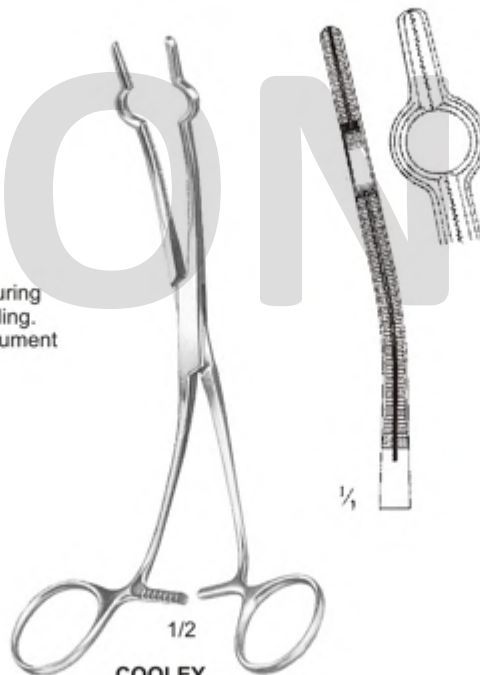

COOLEY
120-0020
child
120-0021
adult

●●● Atrauma Tissue Forceps



DE BAKAY

- 120-0022 160mm (6.1/4")
- 120-0023 200mm (8")
- 120-0024 240mm (9.1/4")
- 120-0025 300mm (12")

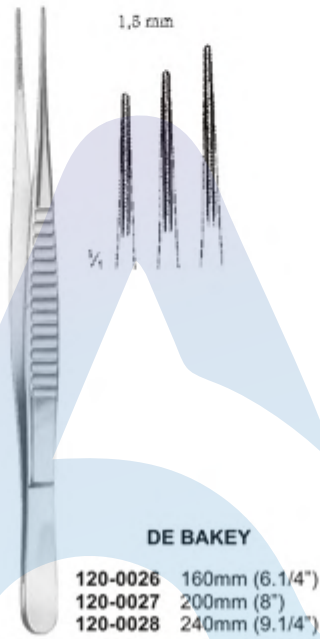

DE BAKAY

- 120-0026 160mm (6.1/4")
- 120-0027 200mm (8")
- 120-0028 240mm (9.1/4")

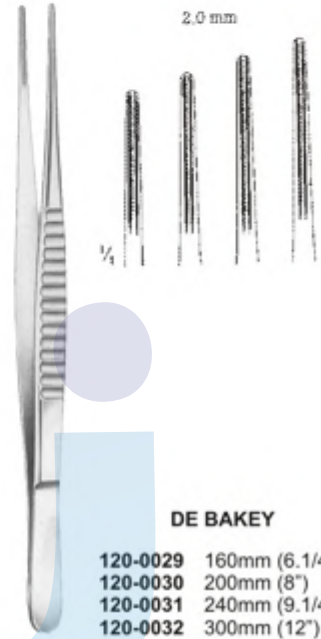

DE BAKAY

- 120-0029 160mm (6.1/4")
- 120-0030 200mm (8")
- 120-0031 240mm (9.1/4")
- 120-0032 300mm (12")

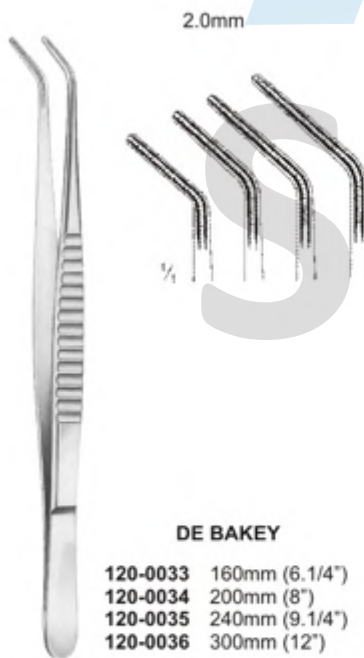

DE BAKAY

- 120-0033 160mm (6.1/4")
- 120-0034 200mm (8")
- 120-0035 240mm (9.1/4")
- 120-0036 300mm (12")



DE BAKAY

- 120-0037 160mm (6.1/4")
- 120-0038 200mm (8")
- 120-0039 240mm (9.1/4")
- 120-0040 300mm (12")



COOLEY

- 120-0041 160mm (6.1/4")
- 120-0042 200mm (8")

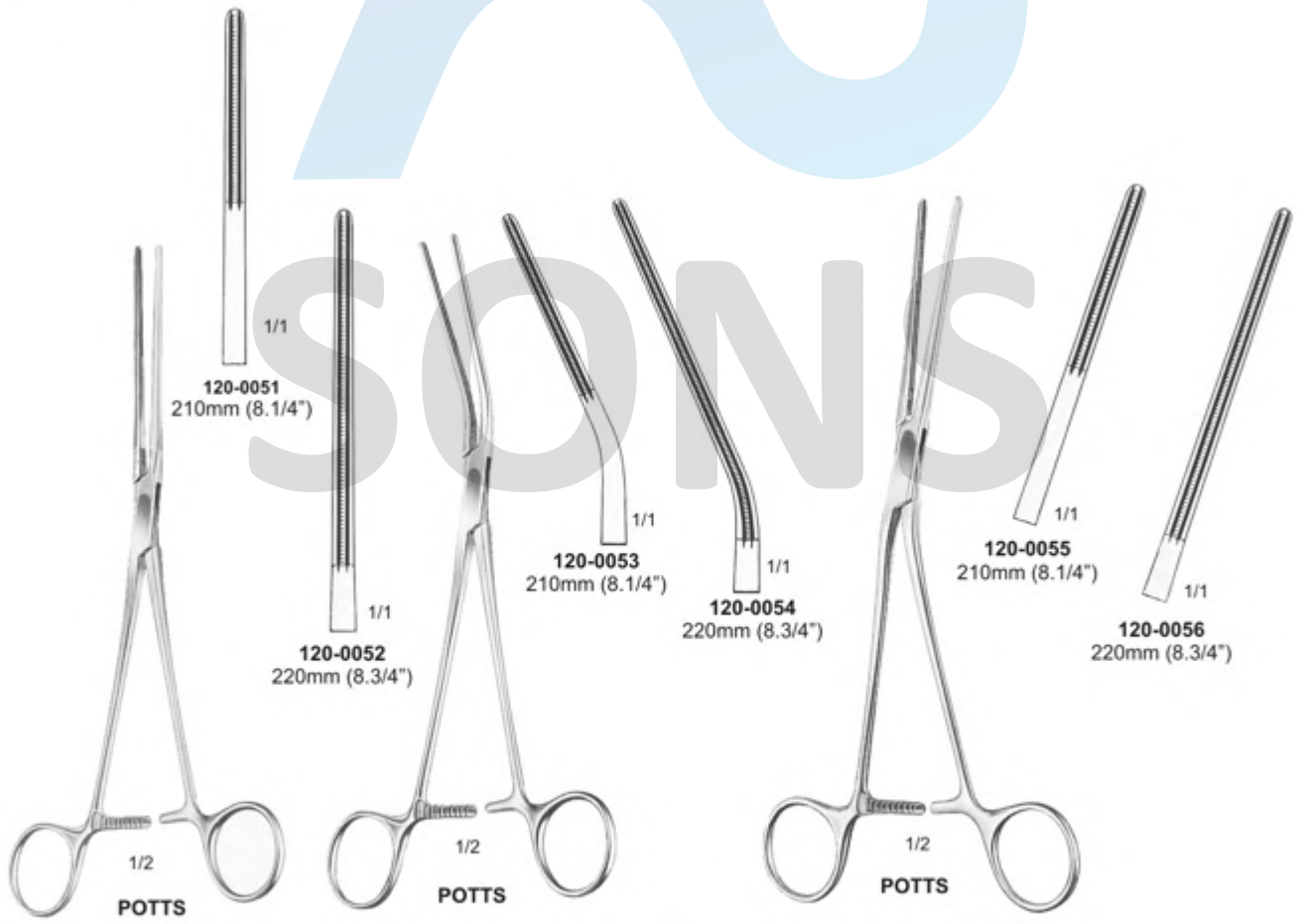
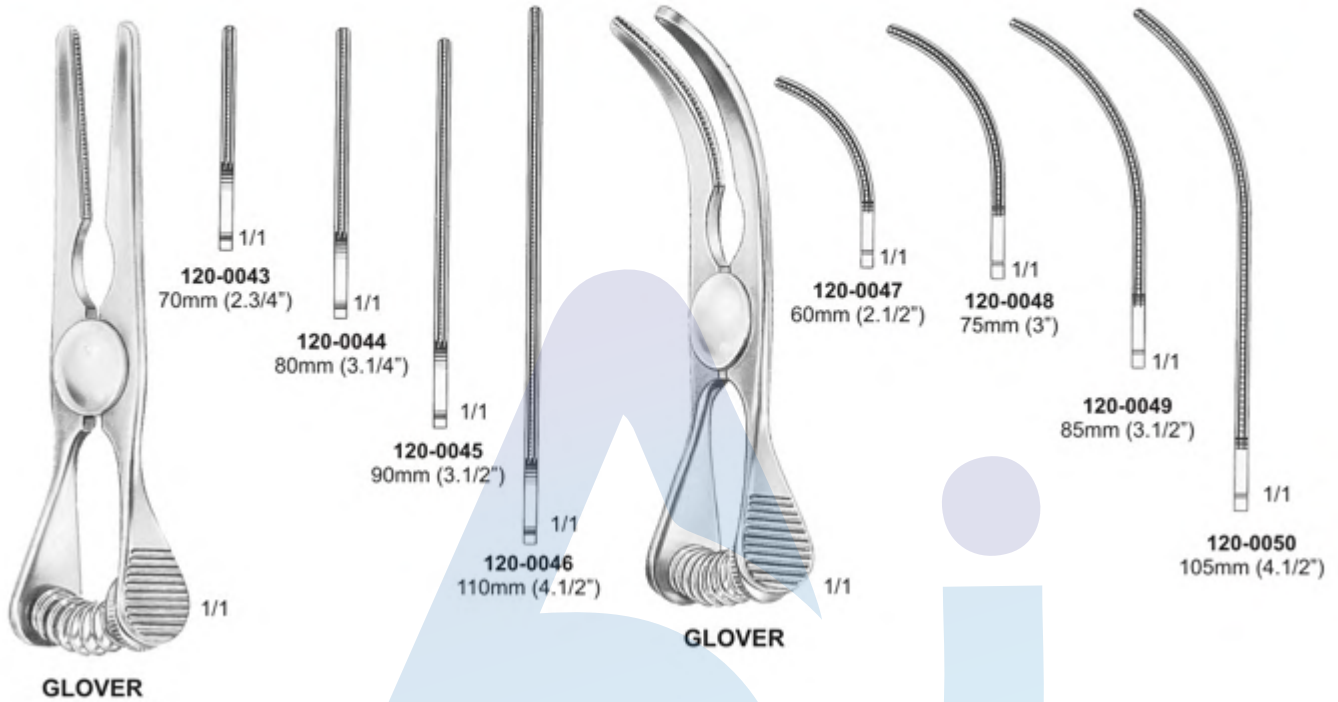

●●● Atrauma Cardiovascular Forceps

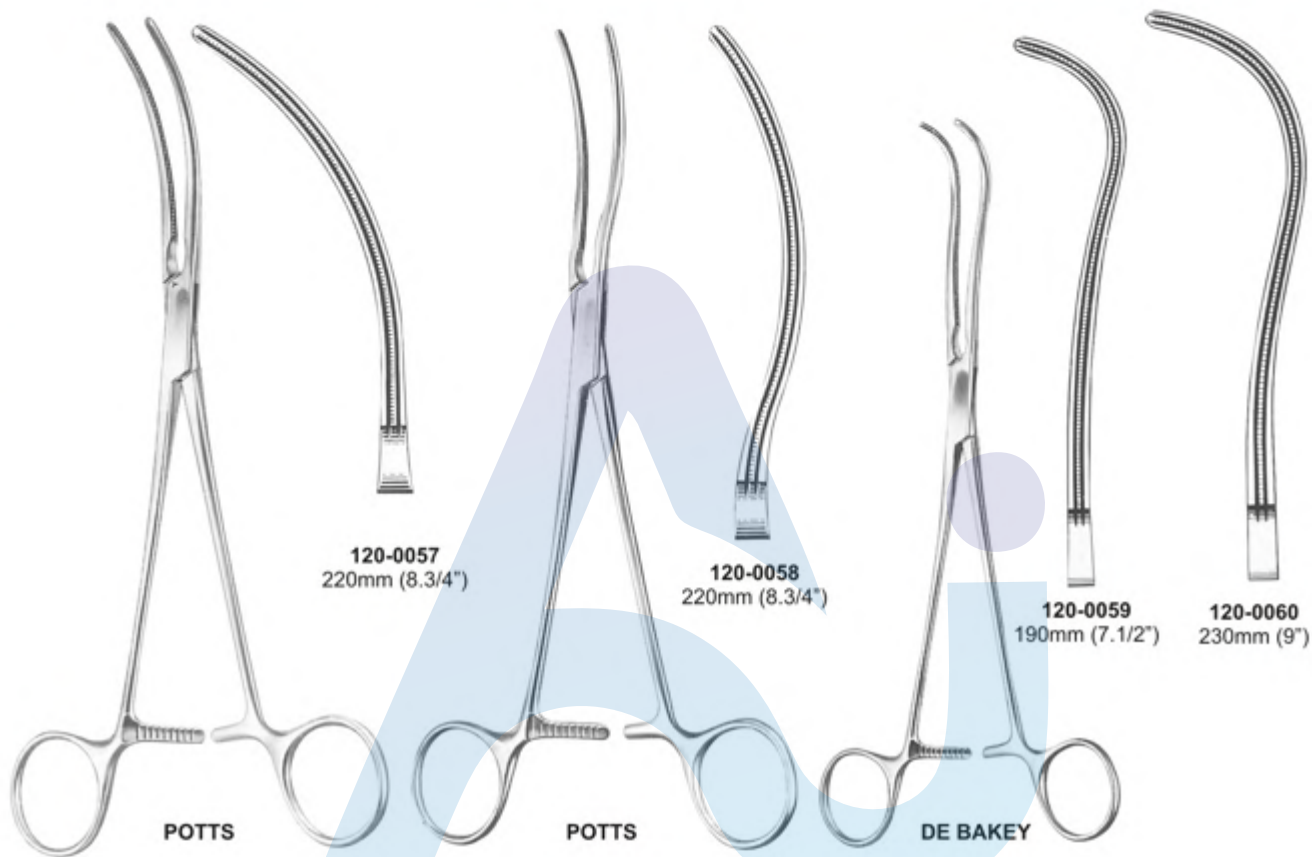

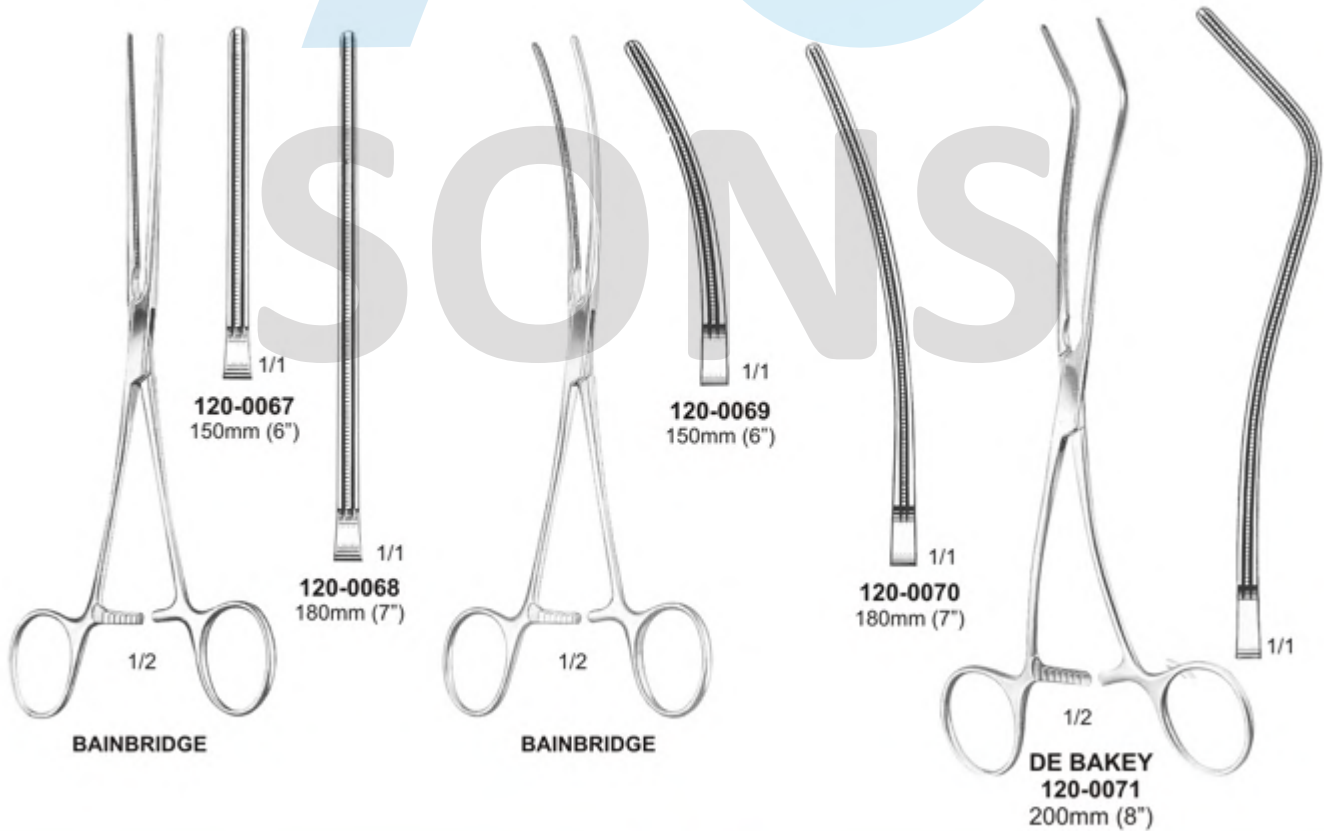
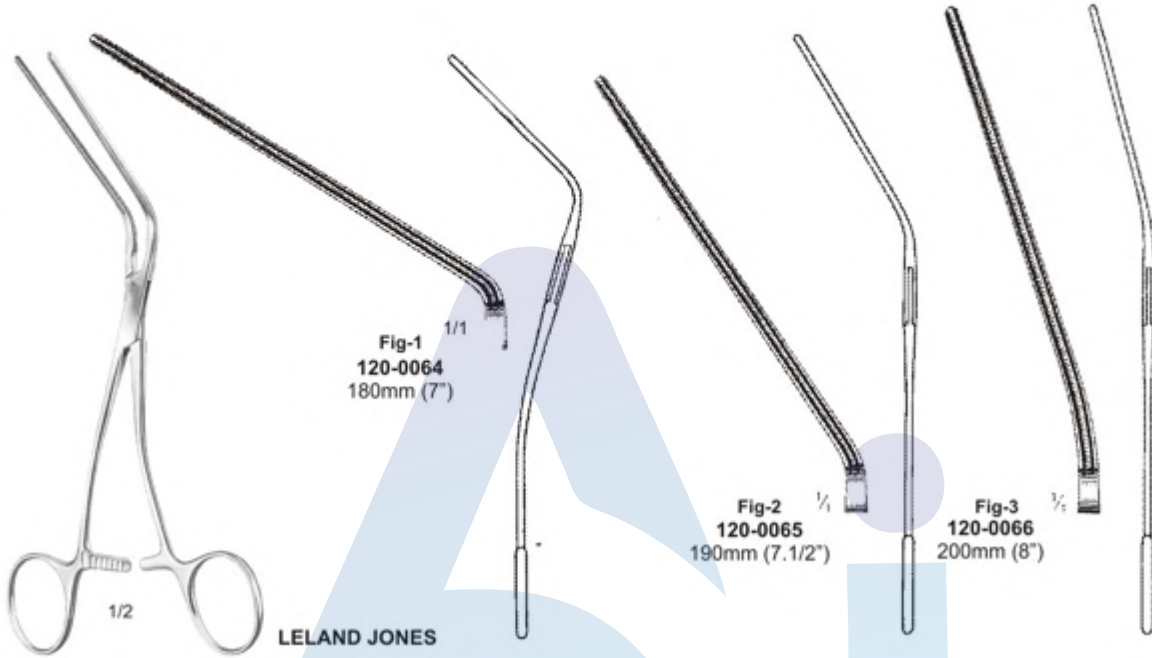

●●● Atrauma Cardiovascular Forceps



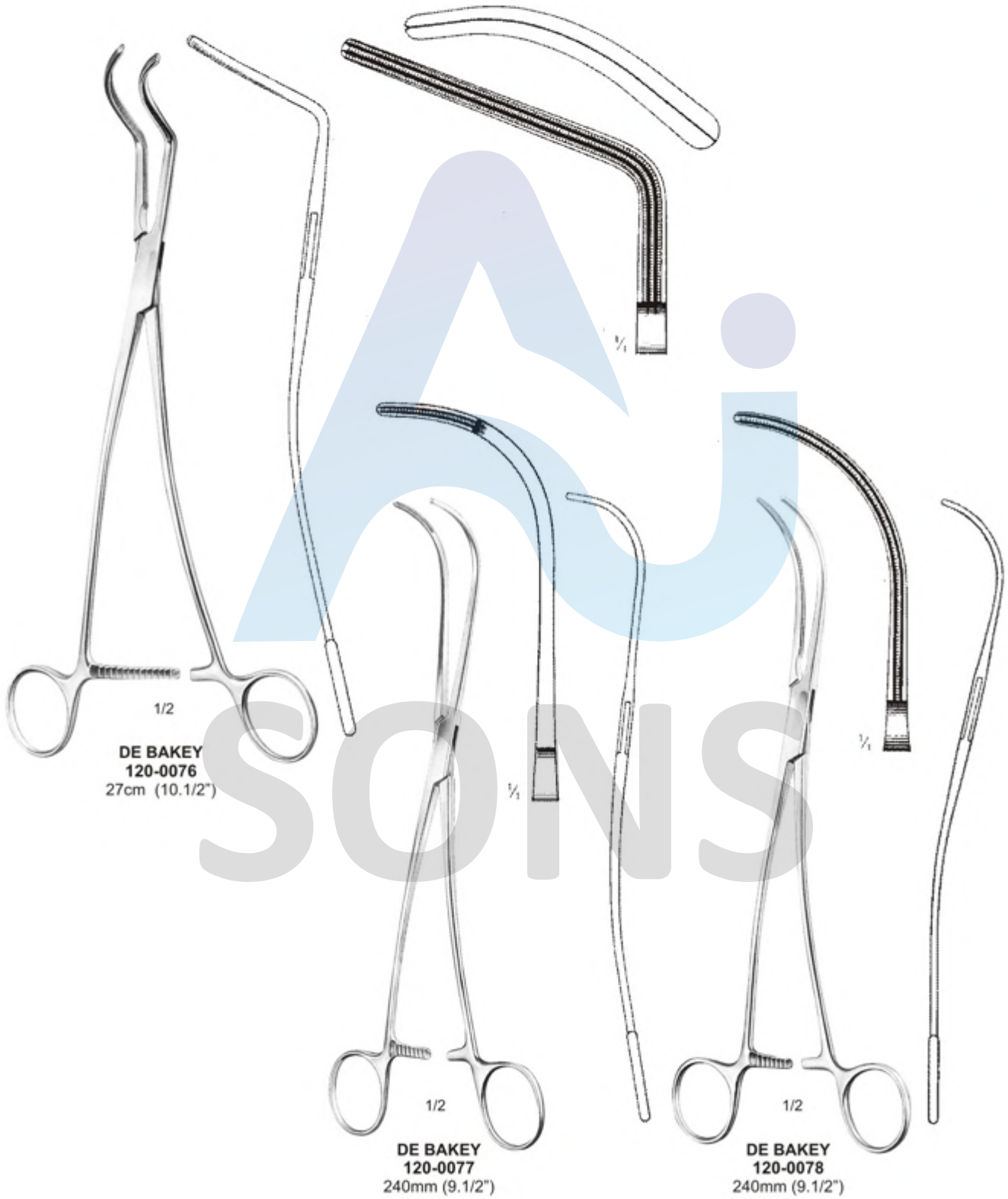

●●● Atrauma Cardiovascular Forceps



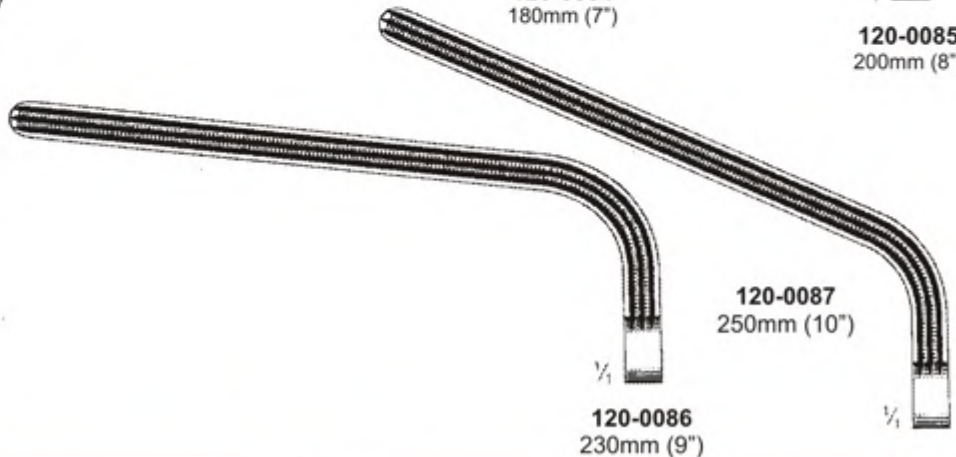
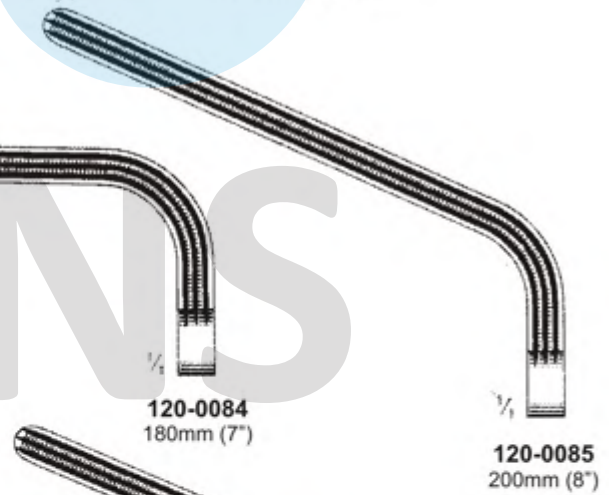
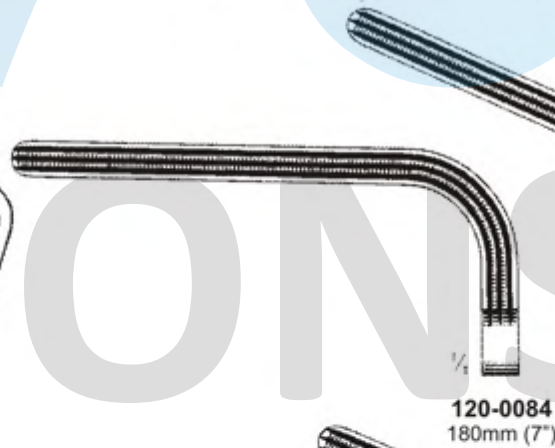

120-0087
250mm (10")

●●● Atrauma Cardiovascular Forceps

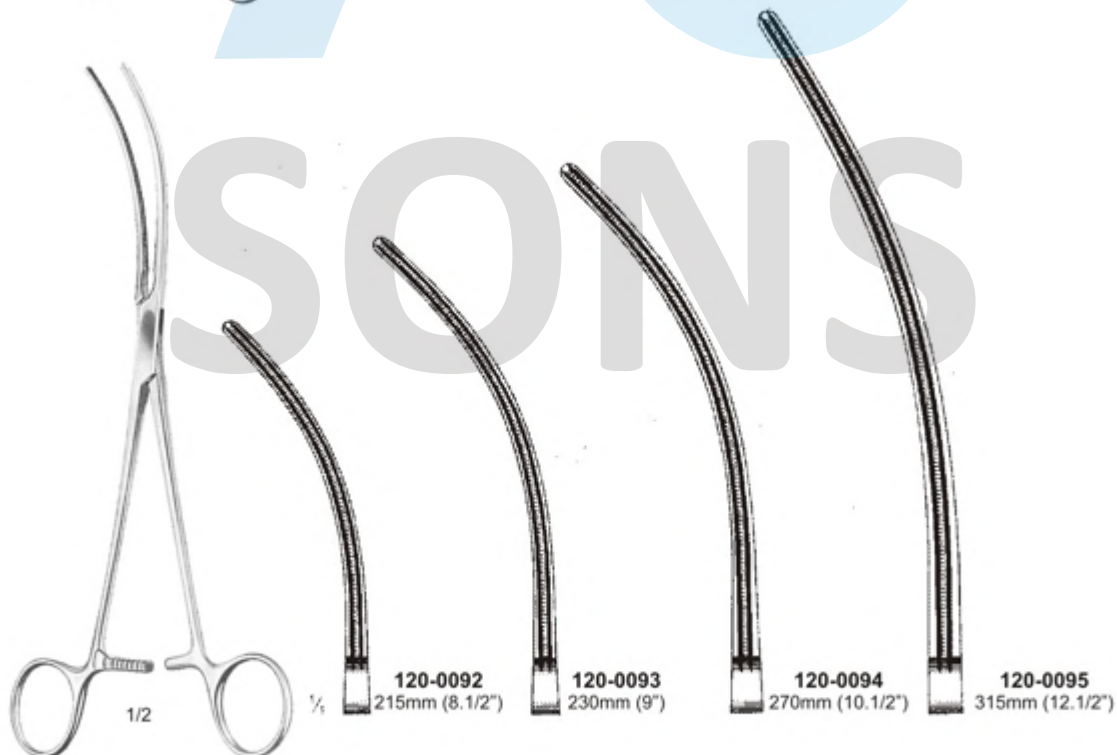
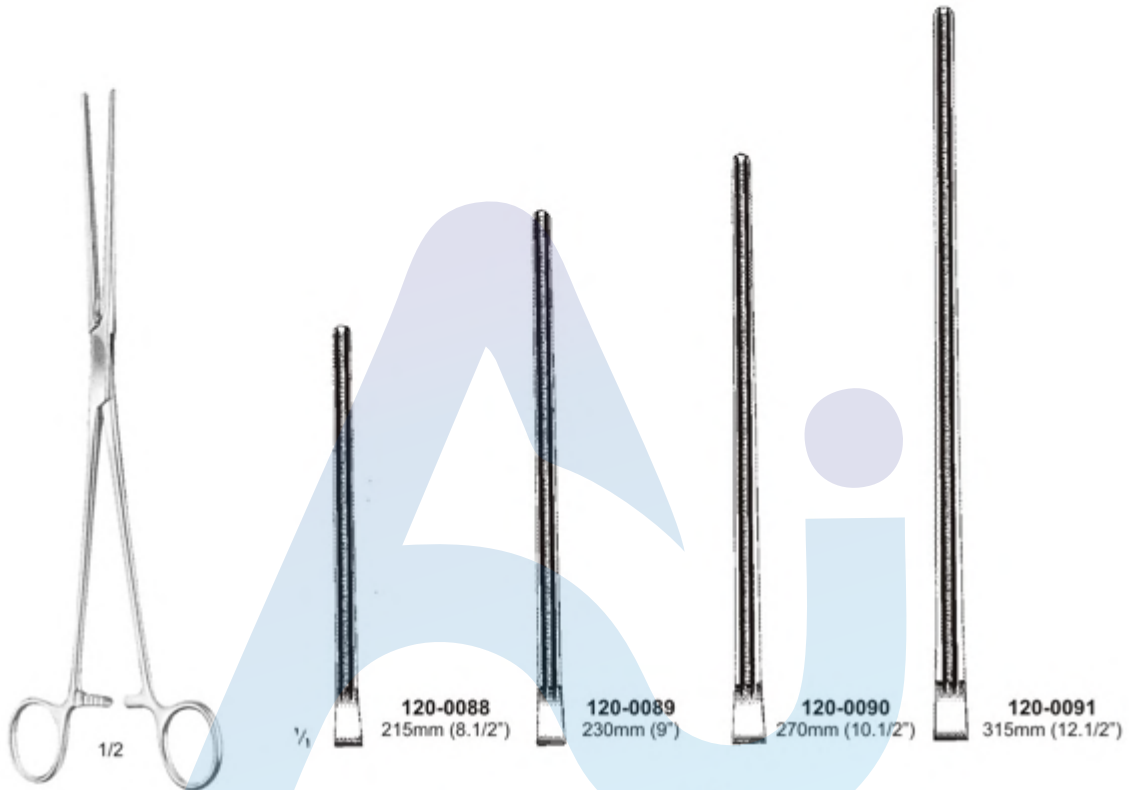

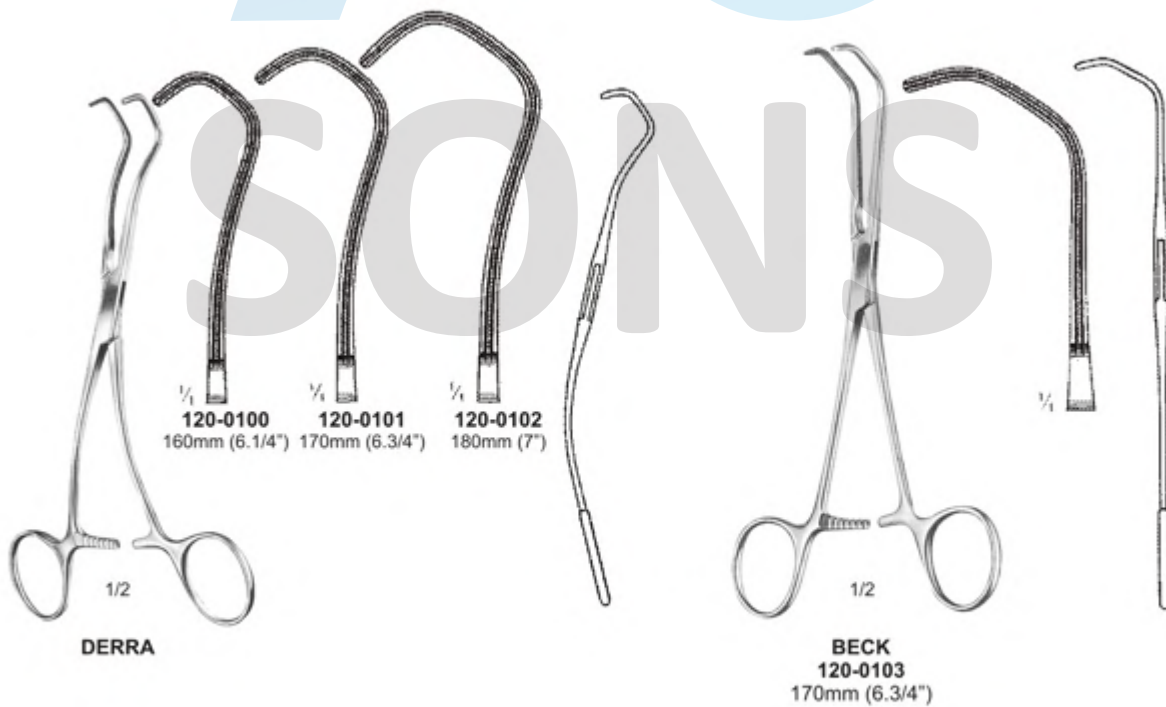

●●● Vascular Dilators

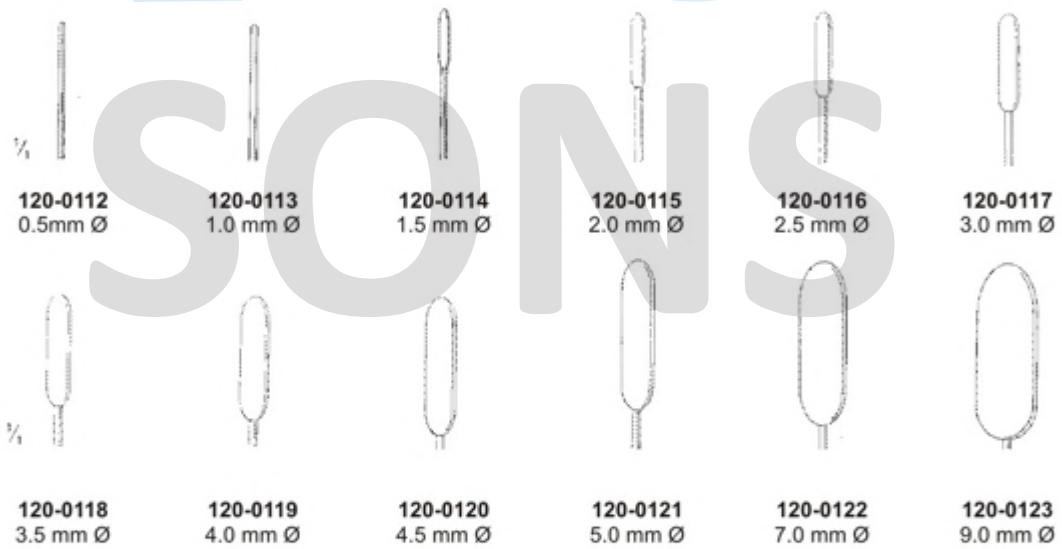
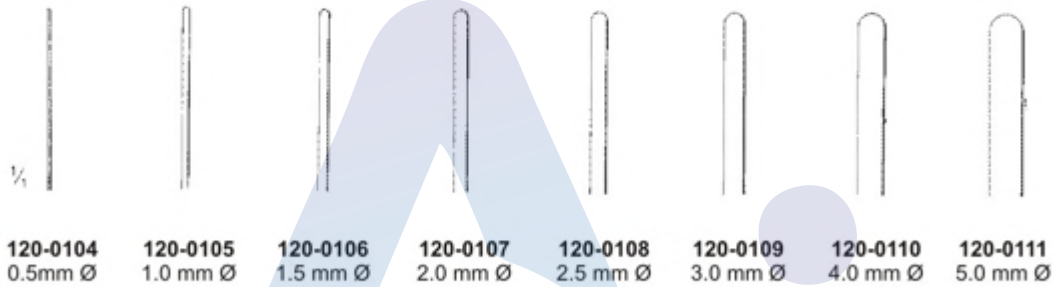

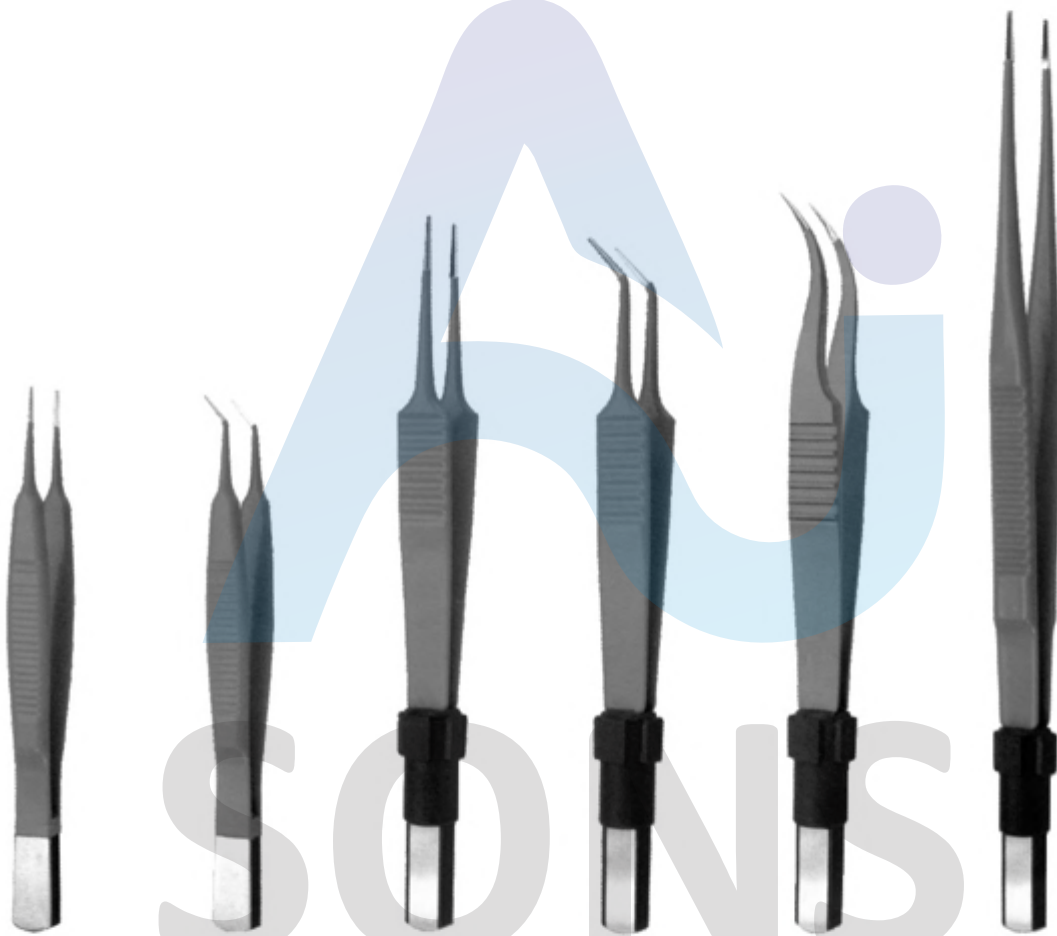

McPHERSON
121-0001
70mm
(2.3/4")
Straight

McPHERSON
121-0002
70mm
(2.3/4")
Angled

JEWELER
FORCEPS
121-0003
110 mm
(4.1/4")
Straight

JEWELER
FORCEPS
121-0004
110 mm
(4.1/4")
Angled

JEWELER
FORCEPS
121-0005
110 mm
(4.1/4")
Curved

BIPOLAR FORCEPS
Straight
121-0006 150mm (6")
121-0007 180mm (7")
121-0008 200mm (8")
121-0009 220mm (8.1/2")
121-0010 240mm (9.1/2")

●●● Bipolar Forceps



**BIPOLAR FORCEPS
BAYONETT**

121-0011 180mm (7")
121-0012 200mm (8")
121-0013 220mm (8.1/2")
121-0014 240mm (9.1/2")

**BIPOLAR FORCEPS
Angled downward**

121-0015 150mm (6")
121-0016 180mm (7")
121-0017 200mm (8")
121-0018 220mm (8.1/2")
121-0019 240mm (9.1/2")

**BIPOLAR FORCEPS
BAYONETT
Angled Upward**

121-0020 180mm (7")
121-0021 200mm (8")
121-0022 220mm (8.1/2")
121-0023 240mm (9.1/2")

**BIPOLAR FORCEPS
BAYONETT
Angled Downward**

121-0024 180mm (7")
121-0025 200mm (8")
121-0026 220mm (8.1/2")
121-0027 240mm (9.1/2")

Monopolar Cables, Forceps ●●●

MONOPOLAR CABLES



- 121-0028** 3 meter cable, Hook connector, cable with active instrument connector
- 121-0029** 5 meter cable, Hook connector, cable with active instrument connector



- 121-0030** 3 meter cable, 4mm plug, cable with active instrument connector
- 121-0031** 5 meter cable, 4mm plug, cable with active instrument connector



- 121-0032** 3 meter cable, 8mm jack plug (Bovie) cable with active instrument connector
- 121-0033** 5 meter cable, 8mm jack plug (Bovie) cable with active instrument connector



DISSECTING FORCEPS
121-0034
 150mm (6")
 180mm (7")



DISSECTING FORCEPS
121-0035
 200mm (8")
 250mm (10")



MCINDOE FORCEPS
121-0036
 150mm (6")



ADSON
121-0037
 100mm (7.1/2")



WILSON HEY FORCEPS
121-0038
 150mm (6")

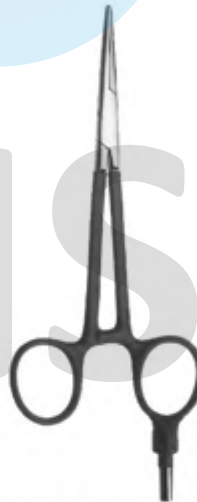

WILSON HEY FORCEPS
121-0039 180mm (7")
121-0040 230mm (9")

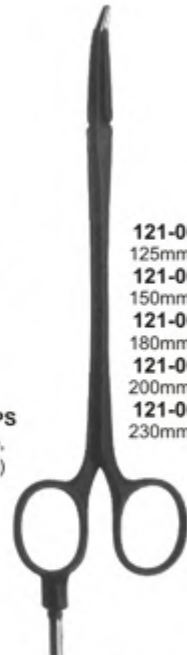

RICHES FORCEPS

- 121-0041** 125mm (5")
- 121-0042** 150mm (6")
- 121-0043** 180mm (7")
- 121-0044** 200mm (8")
- 121-0045** 230mm (9")

●●● Monopolar Handles, Blades, Needle, Turner W



HANDLES
For ball and plate electrode carriers
121-0046
17mm (6.1/4")



HANDLES
For needles and loops
121-0047
200mm (8")



HANDLES
For needles and loops
121-0048
15mm (6")



BLADES
121-0049
Large Diathermy blade electrode (Insulated)



BLADES
121-0050
Large Diathermy blade electrode (Non-Insulated)



BLADES
121-0051
Small Diathermy blade electrode



NEEDLE
121-0052
Short Sharp



NEEDLE
121-0053
Long Insulated



NEEDLE
121-0054
Long Sharp Angled



NEEDLE
121-0055
Long Sharp Straight



TURNER WARWICK SCISSOR
121-0056 125mm (5")
121-0057 145mm (5.1/4")
121-0058 150mm (6")
121-0059 180mm (7")
121-0060 230mm (9")



SCALPLE HANDLE
121-0061
No3, No4



122-0001

- 1- BLOW PIPE
- 2- 3 PCS. SCALPEL
- 3- DISSECTING FORCEP 13 CM.
- 4- GROOVED DIRECTOR WITH TONGUE TIE 13 CM
- 5- TRIPLE CHAIN HOOK
- 6- DRESSING SCISSORS PROBE POINTED 13 CM
- 7- PROBE DOUBLE 13 CM
- 8- ZIPPER CASE INSIDE RED VELVET.

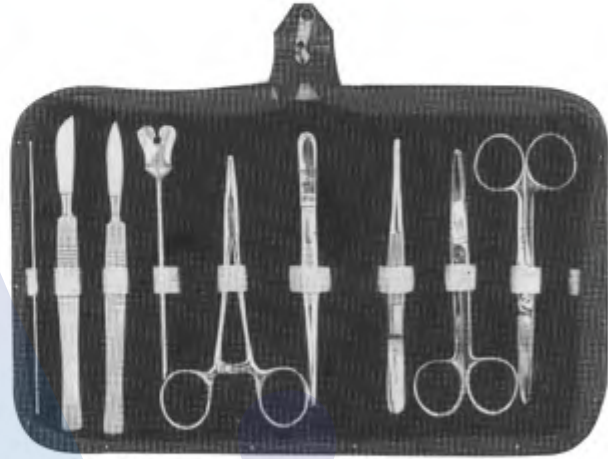

122-0002

- 1- PROBE DOUBLE 13 CM
- 2- 2 PCS. SCALPEL S.S.
- 3- GROOVED DIRECTOR WITH TONGUE TIE 13 CM
- 4- MAYO HEGAR NEEDLE HOLDER 13CM
- 5- DISSECTING FORCEP 13 CM 1x2 TEETH
- 6- DRESSING FORCEP 13 CMS SERRATED.
- 7- DRESSING SCISSOR 13 CM S/B STR.
- 8- DRESSING SCISSOR 13 CM S/B CVD.
- 9- ZIPPER CASE INSIDE RED VELVET.

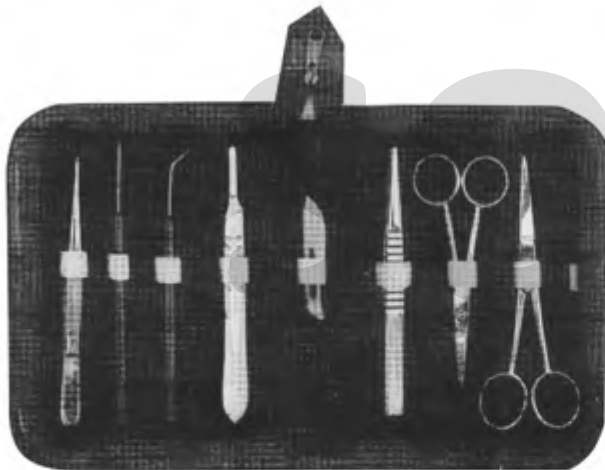

122-0003

- 1- DISSECTING FORCEP 11.5 CM SHARP POINT.
- 2- TEASING NEEDLE SHARP STR.
- 3- B.P HANDLE NO. 4
- 4- TEASING NEEDLE SHARP ANGULAR
- 5- BLADE NO. 22
- 6- THUMB FORCEP T.O.E. 13 CM
- 7- DISSECTING SCISSOR STR 11.5 CM
- 8- DISSECTING SCISSOR STR 13 CM
- 9- ZIPPER CASE INSIDE RED VELVET.



122-0004

- 1- GROOVED DIRECTOR WITH TONGUE TIE 14 CM
- 2- PROBE DOUBLE 14CM
- 3- MAYO HEGAR NEEDLE HOLDER 14 CM
- 4- BP. HANDLE NO.3
- 5- BP. HANDLE NO.4
- 6- DRESSING SCISSOR 14 CM S/B STR
- 7- DRESSING SCISSOR 14 CM S/B CVD.
- 8- DRESSING FORCEP 1x2 TEETH 14 CM
- 9- DRESSING FORCEP SERRATED 14 CM

●●● Dissection Instruments



122-0005

- 1- PROBE DOUBLE 12.5 CM
- 2- SCALPEL
- 3- B.P. HANDLE NO. 4
- 4- 6 PCS BLADE 2 EACH NO. 21, 22, 23
- 5- DISSECTING FORCEP 12.5 CM
- 6- DISSECTING FORCEP 11.5 CM SHARP POINT.
- 7- DRESSING SCISSOR S/B STR. 13 CM
- 8- DRESSING SCISSOR S/S STR. 13 CM



122-0006

- 1- TEASING NEEDLE WITH CHUCK CVD.
- 2- HUBER PROBE
- 3- IRIS SCISSOR
- 4- DISSECTING FORCEP FINE 14 CM.
- 5- DISSECTING FORCEP FINE CVD. 12 CM
- 6- OPERATING SCISSOR WITH PROBE 14 CM.
- 7- B.P. HANDLE NO. 4

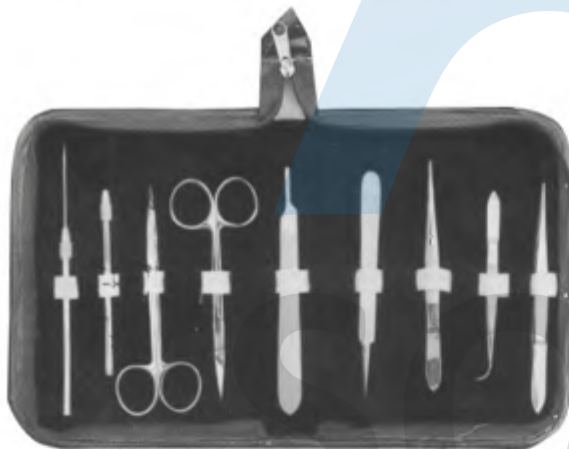

122-0007

- 1- DISSECTING FORCEP FINE 14 CM.
- 2- DISSECTING FORCEP FINE CVD 12 CM.
- 3- DISSECTING FORCEP WITH PIN 14 CM.
- 4- WATCHMAKER FINE POINT
- 5- IRIS SCISSOR STR
- 6- IRIS SCISSOR CVD.
- 7- TEASING NEEDLE HOLDER
- 8- TEASING NEEDLE STR.
- 9- B.P. HANDLE NO. 3



122-0008

- 1- TEASING NEEDLE STR.
- 2- GROOVED DIRECTOR AND TONGUE TIE.
- 3- TEASING NEEDLE CVD.
- 4- DISSECTING FORCEP WITH PIN 12 CM FINE
- 5- OPERATING SCISSOR S/B STR 14 CM
- 6- TRIPLE CHAIN HOOK
- 7- PROBE WITH EYE
- 8- PROBE DOUBLE END
- 9- PROBE AND HOOK
- 10- DISSECTING FORCEP FINE 14 CM
- 11- IRIS SCISSOR
- 12- HUBER PROBE
- 13- B.P. HANDLE NO. 3
- 14- B.P. HANDLE NO. 4



122-0009

- 1- PROBE WITH EYE
- 2- DISSECTING FORCEP CVD FINE 12 CM.
- 3- IRIS SCISSOR
- 4- OPERATING CCISSOR S/B STR 14 CM
- 5- GROOVED DIRECTOR AND TONGUE TIE
- 6- HUBER PROBE
- 7- TRIPLE CHAIN HOOK
- 8- B.P. HANDLE NO. 4
- 9- B.P. HANDLE NO. 3
- 10- TEASING NEEDLE WITH CHUCK CVD.
- 11- TEASING NEEDLE WITH CHUCK STR.
- 12- DISSECTING FORCEPS FINE 14 CM



122-0010

- 1- PROBE DOUBLE END
- 2- GROOVED DIRECTOR AND TONGUE TIE
- 3- B.P. HANDLE NO. 4
- 4- OPERATING SCISSOR STR S/B 14 CM.
- 5- KELLY FORCEPS STR 14 CM.
- 6- DISSECTING FORCEPS THUMB 13 CM.

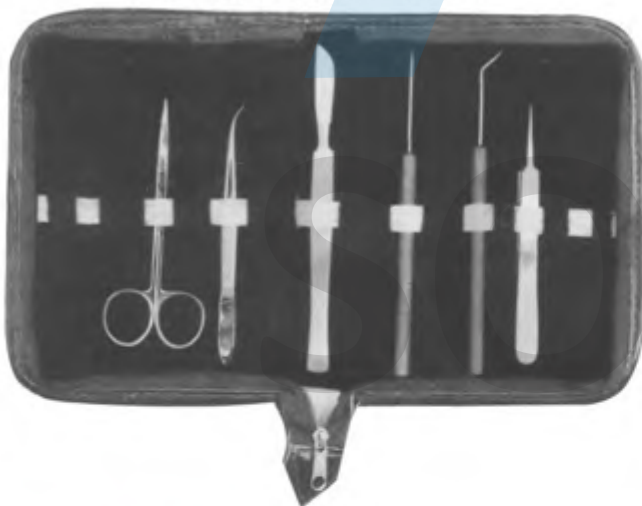

122-0011

- 1- IRIS SCISSOR STR
- 2- DISSECTING FORCEP CVD FINE 12 CM
- 3- SCALPEL
- 4- TEASING NEEDLE STR WOODEN HANDLE
- 5- TEASING NEEDLE CVD WOODEN HANDLE
- 6- WATCHMAKER FINE POINT



122-0012

- 1- DISSECTING FORCEP FINE STR WITH PIN 12 CM
- 2- IRIS SCISSOR STR
- 3- PROBE WITH EYE
- 4- PROBE AND HOOK
- 5- OPERATING SCISSOR S/B STR 14 CM
- 6- TRIPLE CHAIN HOOK
- 7- B.P. HANDLE NO. 4
- 8- HUBER PROBE
- 9- B.P. HANDLE NO. 3
- 10- TASING NEEDLE STR PLASTIC HANDLE
- 11- TASING NEEDLE CVD PLASTIC HANDLE
- 12- GROOVED DIRECTOR AND TONGUE TIE
- 13- PROBE DOUBLE END

●●● Dissection Instruments



122-0013

- 1- GROOVED DIRECTOR AND TONGUE TIE
- 2- MAYO HEGAR NEEDLE HOLDER 14 CM.
- 3- B.P. HANDLE NO.4
- 4- DISSECTING FORCEP THUMB 14 CM.
- 5- OPERATING SCISSOR S/B STR 14 CM.
- 6- KELLY FORCEP 14 CM STR
- 7- PROBE DOUBLE END



122-0014

- 1- DISSECTING FORCEP THUMB 14 CM
- 2- DISSECTING FORCEP 1x2 TEETH 14 CM
- 3- B.P. HANDLE NO. 3
- 4- GROOVED DIRECTOR AND TONGUE TIE
- 5- MAYO HEAGR NEEDLE HOLDER 14 CM.
- 6- OPERATING SCISSOR S/B STR 14 CM.
- 7- PROBE DOUBLE END
- 8- KELLY FORCEP STR 14 CM.



122-0015

- 1- PROBE DOUBLE END
- 2- B.P. HANDLE NO. 4
- 3- DISSECTING FORCEP 1x2 TEETH 14 CM.
- 4- OPERATING SCISSOR S/B 14 CM STR.
- 5- MAYO HEAGR NEEDLE HOLDER 14 CM.
- 6- KELLY FORCEP STR 14 CM.
- 7- OPERATING SCISSOR S/B CVD 14 CM.
- 8- GROOVED DIRECTOR AND TONGUE TIE
- 9- DISSECTING FORCEP THUMB 14 CM.



122-0016

- 1- PROBE DOUBLE END
- 2- DISSECTING FORCEP 1x2 TEETH 14 CM.
- 3- KELLY FORCEP CVD 14 CM.
- 4- OPERATING SCISSOR S/B 14 CM CVD.
- 5- MAYO HEAGR NEEDLE HOLDER 14 CM.
- 6- B.P. HANDLE NO.4
- 7- OPERATING SCISSOR S/B 14 CM STR.
- 8- KELLY FORCEP STR. 14 CM.
- 9- DISSECTING FORCEP THUMB 14 CM
- 10- GROOVED DIRECTOR AND TONGUE TIE



123-0001



123-0002



123-0007

123-0008



123-0006



123-0004

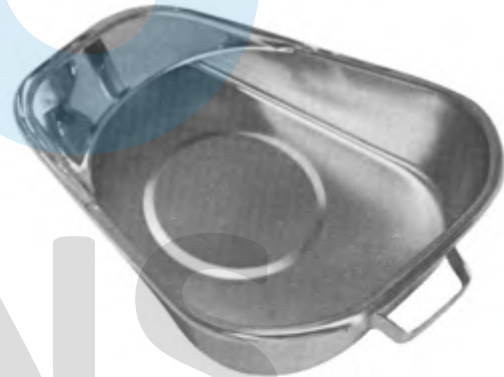

123-0003
123-0005

BED PANS, Perfection Type

INSTRUMENTS #		LENGTH		WIDTH		FRONT	HEIGHT	BACK	
123-0001	Adult	14"	355mm	11-3/8"	290mm	4-3/8"	110mm	2-5/8"	67mm
123-0002	Child	12-1/8"	308mm	9-3/4"	80mm	3-1/8"	80mm	1-3/4"	45mm

BED PANS, Practure Type

123-0003		11-7/8"	300mm	9-1/4"	235mm	2-7/8"	72mm	1"	25mm
123-0004		Same as above but with cover							
123-0005	Large	14-1/8"	360mm	10"	255mm	3- 1/8"	90mm	1"	25mm

URINALS MALE

		CAPACITY			DIAMETER		HEIGHT	
123-0006	Horizontal	1-3/4" Qts.	1.7" Qts.		4-1/2"	115mm	9-1/2"	240mm
123-0007	Upright Junior	1.0 Qts.	0.9 Qts.		3-3/4"	95mm	8"	203mm
123-0008	Upright Adult	1.5/8 Qts.	1.5 Qts.		4"	100mm	8-7/8"	225mm

●●● Patient Treatment Items



PATIENT TREATMENT ITEMS DRESSING JARS w/cover

CAT. No.	Capacity	Diameter	Height
123-0009	½ Qt. 0.47l	4-1/8" 105mm	2-3/8" 60mm
123-0010	1Qt. 0.95l	4-1/8" 105mm	5-1/4" 135mm
123-0011	2-1/4 Qts. 2.13l	4-7/8" 125mm	6-3/4" 170mm
123-0012	4-½ Qts. 4.26l	7-1/4" 185mm	6-7/8" 175mm
123-0013	5/16 Qt. 0.32l	3-1/2" 90mm	2-1/8" 55mm
123-0014	7/16 Qt. 0.4l	4" 100mm	2-1/4" 57mm
123-0015	11/16 Qt. 0.67l	4-3/4" 120mm	2-3/8" 61mm
123-0016	1-1/16 Qts. 1.0l	5-1/2" 140mm	3" 75mm

NEEDLE/OINTMENT JARS w/cover

123-0017	1/4 Qt. 0.24l	3" 75mm	2-1/2" 65mm
123-0018 - Same as above but with plain cover-			

FORCEPS JARS w/Heavy base and Light base

CAT. No.	Tube Diameter	Base Diameter	Height
123-0019 Heavy base	2-1/8" 55mm	4" 100mm	4-1/2" 115mm
123-0020 Heavy base	2-1/8" 55mm	4" 100mm	7-1/4" 185mm
123-0021 Light base	2-3/8" 60mm	3-1/8" 80mm	4" 100mm
123-0022 Light base	3" 75mm	3-3/4" 95mm	4-3/4" 120mm
123-0023 Light base	3-1/28" 90mm	4-1/2" 115mm	6-1/8" 155mm
123-0024 Light base	4" 100mm	4-7/8" 125mm	6-3/4" 170mm

THERMOMETER JAR

123-0025	1" 25mm	2-1/8" 55mm	4" 100mm
----------	---------	-------------	----------

STETHOSCOPES

123-0026	Combination Stethoscope chest piece turnable, light meta, one side with diaphragm, other side bell type	Chest piece only, ø 47mm
----------	---	--------------------------

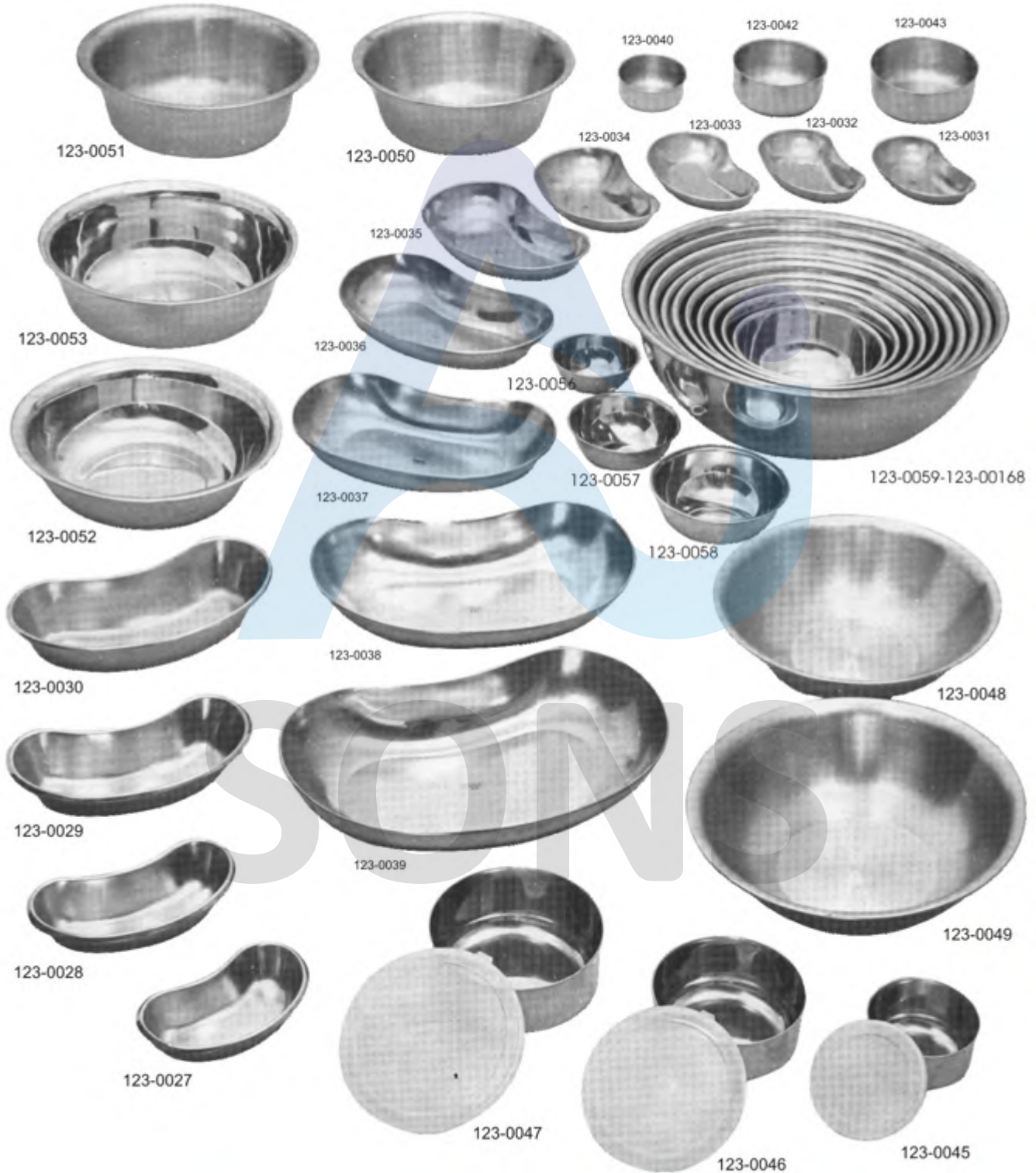

●●● Treatment Room Items

EMESIS BASINS (Kidney trays), deep

INSTRUMENTS #	LENGTH		WIDTH		DEPTH	
123-0027	6"	150mm	3-1/2"	90mm	1-1/2"	40mm
123-0028	8"	205mm	3-3/4"	95mm	1-3/4"	45mm
123-0029	10"	255mm	4-1/2"	115mm	2-1/8"	55mm
123-0030	12"	305mm	5-1/2"	140mm	2-1/2"	65mm

EMESIS BASINS (Kidney Trays), shallow, light gauge

123-0031	7-7/8"	200mm	4-3/8"	110mm	1-1/4"	30mm
123-0032	8-1/2"	215mm	4-1/2"	115mm	1-3/8"	35mm
123-0033	9"	230mm	5"	125mm	1-3/8"	35mm
123-0034	9-5/8"	245mm	5-1/2"	140mm	1-5/8"	40mm
123-0035	11-1/4"	285mm	6-1/4"	160mm	1-3/4"	45mm
123-0036	12-3/8"	315mm	6-7/8"	175mm	2"	50mm
123-0037	13"	330mm	7-1/4"	185mm	2-1/8"	55mm
123-0038	14-5/8"	370mm	8-1/2"	215mm	2-3/8"	60mm
123-0039	16-1/8"	410mm	9-5/8"	245mm	2-1/2"	65mm

SPONGE BOWLS

INSTRUMENTS #	CAPACITY		DIAMETER		DEPTH	
123-0040	3/8 Qt.	0.36	4-1/8"	105mm	2"	50mm
123-0041	5/8 Qt.	0.6	5"	125mm	2-1/4"	57mm
123-0042	1.0 Qt.	0.95	5-3/4"	145mm	2-1/2"	65mm
123-0043	1-3/8 Qts.	1.3	6-1/2"	165mm	3"	75mm
123-0044	1-7/8 Qts.	1.78	7-3/8"	187mm	3"	75mm

SPONGE BOWLS w/plastic cover 18.0 s.s.

123-0045	3/8 Qt.	0.36	4"	100mm	2-1/8"	55mm
123-0046	7/8 Qt.	0.8	5-1/2"	140mm	2-1/2"	65mm
123-0047	1-3/8 Qts.	1.3	6-1/2"	165mm	2-3/4"	70mm

WASH BASINS

123-0048	3-7/8 Qts.	3.7	12-3/8"	315mm	3-1/8"	80mm
123-0049	4-3/4 Qts.	4.5	13-1/4"	335mm	3-5/8"	90mm

SOLUTION BASINS

123-0050	7 Qts.	6.6	13-5/8"	345mm	4-5/8"	115mm
123-0051	8-1/2 Qts.	8.0	14-1/2"	370mm	4-3/4"	120mm
123-0052	4-1/2 Qts.	4.2	12-5/8"	320mm	3-1/8"	80mm
123-0053	5-3/4 Qts.	5.4	12-5/8"	320mm	4-1/8"	105mm
123-0054	6-1/2 Qts.	6.2	13-3/8"	340mm	4-3/8"	110mm
123-0055	8 Qts.	7.6	14-1/8"	360mm	4-5/8"	118mm

LOTION BOWLS, 18.8 s.s. or 18.0 s.s.

123-0056	1/4 Qt.	0.24	4-1/8"	105mm	1-3/4"	45mm	
123-0057	7/16 Qt.	0.4	5-1/8"	130mm	2-1/8"	55mm	
123-0058	3/4 Qt.	0.7	5-7/8"	150mm	2-3/8"	60mm	
123-0059	1-1/4 Qts.	1.2	7-1/8"	180mm	2-3/4"	70mm	
123-0060	2-1/8 Qts.	2.0	8-1/4"	210mm	3-1/2"	90mm	
123-0061	3-3/16 Qts.	3.0	9-1/2"	240mm	4"	100mm	
123-0062	3-3/4 Qts.	4.5	10-5/8"	270mm	4-1/8"	105mm	
123-0063	6-7/8 Qts.	6.5	11-3/4"	300mm	4-3/4"	120mm	
123-0064	8-7/16 Qts.	8.0	13"	330mm	4-7/8"	125mm	
123-0065	10 Qts.	9.5	14-1/8"	360mm	5-1/4"	135mm	
123-0066	13-1/8 Qts.	12.5	15-3/8"	390mm	5-3/4"	145mm	
123-0067	15-5/16 Qts.	15.5	16-1/2"	420mm	6-1/8"	155mm	
123-0068	21-1/8 Qts.	20.0	17-3/4"	450mm	6-3/4"	170mm	
123-0069	Deep not illustratea	1-3/16 Qts.	1.1	6-1/4"	150mm	3-3/8"	85mm
123-0070	Deep not illustratea	1-5/16 Qts.	1.8	7-1/8"	180mm	4"	100mm
123-0071	Deep not illustratea	3-1/8 Qts.	3.0	8-1/4"	210mm	4-1/2"	115mm
123-0072	Deep not illustratea	4-7/16 Qts.	4.2	9-1/2"	240mm	5-1/8"	130mm

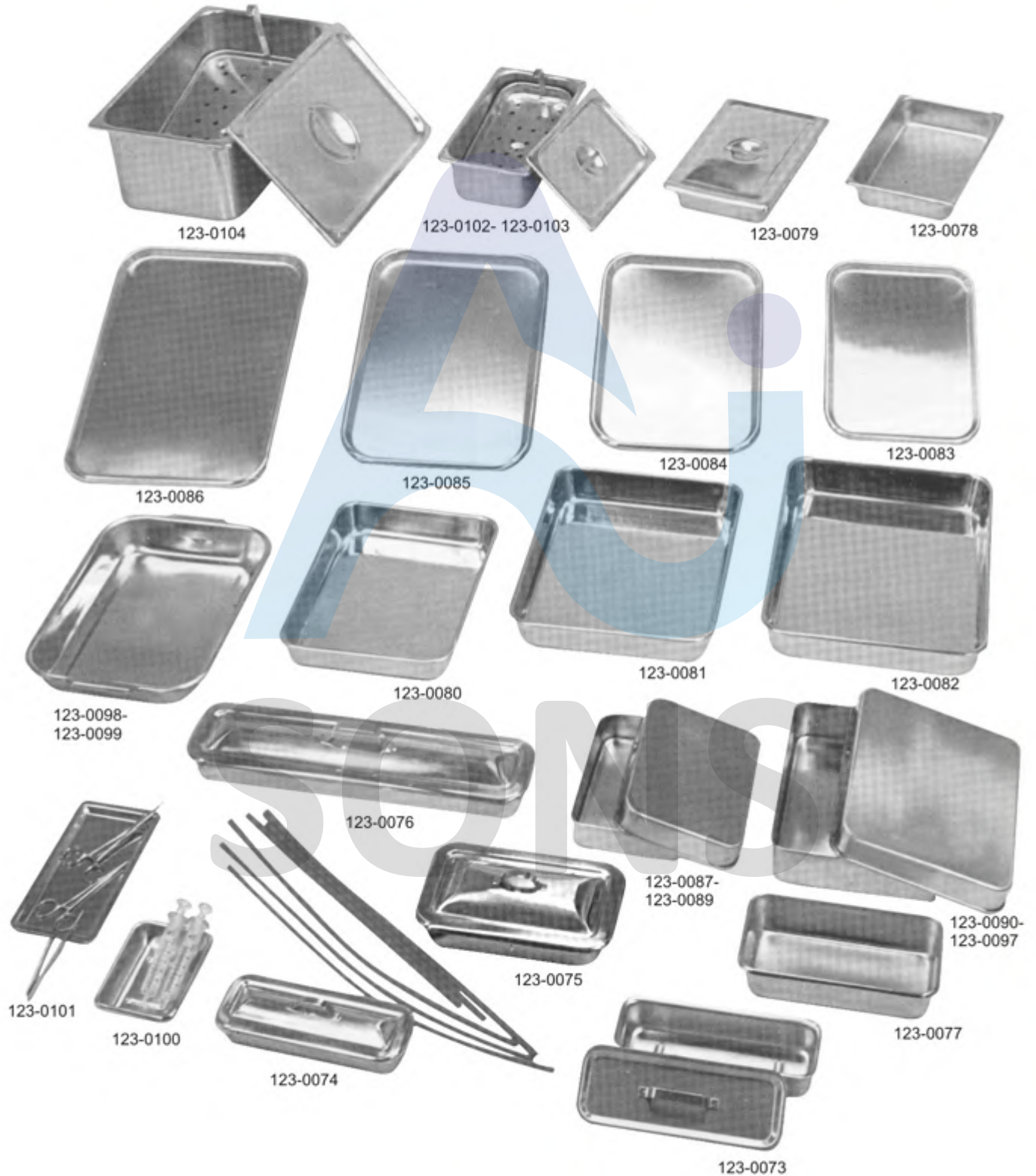

TREATMENT ROOM ITEMS

CATHETER TRAYS w/cover

CAT. No.	Length		Width		Depth	
123-0073	8-3/4"	222mm	3-1/4"	82mm	1-5/8"	40mm
123-0074	8-1/2"	215mm	3"	75mm	1-1/2"	38mm
123-0075	8-7/8"	225mm	5"	125mm	2"	50mm
123-0076	17"	430mm	4"	100mm	2-1/8"	55mm

INSTRUMENT TRAYS

123-0077	8-7/8"	225mm	5"	125mm	2"	50mm
123-0078	12-1/4"	310mm	7-5/8"	195mm	2-1/8"	55mm
123-0079 w/cover	- Same as above -					
123-0080	12-5/8"	320mm	9"	320mm	1-3/4"	45mm
123-0081	14-1/8"	360mm	10-5/8"	270mm	2"	50mm
123-0082	16-1/8"	410mm	11-3/8"	290mm	2-1/8"	55mm

INSTRUMENT TRAYS, Shallow

123-0083	13-1/2"	345mm	9-3/4"	245mm	5/8"	16mm
123-0084	15-1/8"	385mm	10-1/2"	265mm	5/8"	16mm
123-0085	17"	340mm	11-5/8"	295mm	5/8"	16mm
123-0086	19"	485mm	12-1/2"	320mm	5/8"	16mm

INSTRUMENT TRAYS w/set cover

123-0087	8-1/4"	210mm	6"	150mm	1-5/8"	40mm
123-0088	9-1/2"	240mm	7-1/8"	180mm	1-5/8"	40mm
123-0089	9-1/2"	240mm	7-1/8"	180mm	2-3/8"	60mm
123-0090	10-5/8"	270mm	8-1/4"	210mm	1-5/8"	40mm
123-0091	10-5/8"	270mm	8-1/4"	210mm	2-3/8"	60mm
123-0092	11-7/8"	300mm	9-1/2"	240mm	1-5/8"	40mm
123-0093	11-7/8"	300mm	9-1/2"	240mm	2-3/8"	60mm
123-0094	13"	330mm	10-5/8"	270mm	1-5/8"	40mm
123-0095	13"	330mm	10-5/8"	270mm	2-3/8"	60mm
123-0096	14-1/8"	360mm	11-7/8"	300mm	1-5/8"	40mm
123-0097	14-1/8"	360mm	11-7/8"	300mm	2-3/8"	60mm

INSTRUMENT TRAYS w/tab handle

123-0098	14-7/8"	375mm	10-1/8"	255mm	2"	50mm
123-0099	16-1/8"	410mm	11-1/8"	280mm	2"	50mm

STERILIZING TRAYS

123-0100	Syringe	5-1/4"	135mm	4"	100mm	1"	25mm
123-0101	Needle	8-1/2"	215mm	4-1/2"	115mm	3/8"	10mm

STERILIZERS, INSTRUMENTS, for fuel heat, including container, perforated lift-out tray and flat cover.

123-0102	12-5/8"	320mm	6-7/8"	175mm	4"	100mm
123-0103	16-3/8"	415mm	9-7/8"	250mm	4"	100mm
123-0104	17-3/4"	450mm	10-5/8"	270mm	7-1/8"	180mm

INDEX

A

American Pattern (Scissors)	10
Aufricht (Scissors)	10
Adson (Delicate Dissecting Forceps)	17,8
Adson-brown (Delicate Dissecting Forceps)	8
Arthure (Splinter Forceps)	22
Adson-brown (Delicate Dissecting Forceps)	18
Arthure (Splinter Forceps)	22
Allis (Tissue Forceps)	26
American Pattern Allis (Tissue Forceps)	26
Arruga (Micro)	43
Anel Lachrymal (Probes)	49
Auvard (Vaginal Retractor)	75
Alexander (Cervical Biopsy Forceps)	81
Adson Frazier (Suction Tubes)	95
Adson (Suction Tubes)	95
Amputation Saw (Amputation Instruments)	96
Army Regulation Amputation Saw (Amputation Instruments)	96
Adson (Bone Levers & Raspatories)	98
Aneurysm Clamp (Atrauma Cardiovascular Forceps)	122

B

Barron (Surgical Handles)	05
Braun Stadler (Scissors)	10
Bonney (Serrated Dissecting Forceps)	16
Bickford (Serrated Dissecting Forceps)	16
Bonney (Toothed Dissecting Forceps)	20
Bickford (Toothed Dissecting Forceps)	20
Baby - Adson (Dissecting & Ligature Forceps)	23
Babcock (Tissue Forceps)	25
Ball And Socket (Towel Clamps)	29
Backhaus (Towel Clamps)	29
Bozemann Uterine (Dressing Forceps)	31
Bozemann (Dressing Forceps)	31
Baby - Crile (Haemostats Forceps)	32,33
Birkett (Haemostats Forceps)	40
Barraquer (Micro)	43
Brodie (Probes)	48
Balfour Abdominal (Hand Held Retractors)	60
Berkeley Abdominal (Hand Held Retractors)	62
Brown (Tenaculum Forceps)	78
Bonney Polypi (Ovum Forceps)	80
Bumm (Uterine Cannulae)	85
Bonney (Hysterectomy Clamps)	90
Bladder Spatula (Urology)	92
Barron (Suction Tubes)	95
Belucci (Suction Tubes)	95
Boyd Bone Curette (Bone Levers & Raspatories)	98
Burns (Bone Holding Forceps)	101
Beyer (Bone Rongeurs)	103
Beyer (Bone Rongeurs)	105
Beck Rongeur (Disc Rongeurs)	107
Burford (Rib Spreaders)	111
Bainbridge (Atrauma Cardiovascular Forceps)	121
Beck (Atrauma Cardiovascular Forceps)	127
Bipolar Forceps (Bipolar Forceps)	129,130
Blades	132
(Monopolar Handles, Blades, Needle, Turner Warwick Scissors)	

C

Crafoord (Scissors)	09
Counter Scissors (Scissors)	13
Canadian (Serrated Dissecting Forceps)	15
Cairns Dott (Delicate Dissecting Forceps)	17
Canadian (Toothed Dissecting Forceps)	20
Chaput Poirier (Tissue Forceps)	26

Collin Tongue Forceps (Tongue Depressors)	28
Cushing (Haemostats Forceps)	34
Crafoord (Haemostats Forceps)	34
Cairns (Haemostats Forceps)	34
Crile (Haemostats Forceps)	34,35
Castroviejo (Micro)	43
Converse (Needle Holders)	43
Crile Wood (Needle Holders)	44
Crile Murray (Needle Holders)	44
Cawthorne (Probes)	49
Charnley Suture (Suture Instruments)	51
Cushings Vein (Hand Held Retractors)	57
Cone (Hand Held Retractors)	64
Cusso (Vaginal Speculum)	72
Czerny Rectal Speculum (Proctology)	91
Clutton Urethral Sounds (Urology)	93
Cone Suction Tubes (Suction Tubes)	95
Collier And Morris (Bone Scoops)	99
Cairns (Bone Rongeurs)	103
Cushing Cairns (Disc Rongeurs)	107
Cushing Rongeur (Disc Rongeurs)	107
Cooley (Rib Spreaders)	110
Cooley (Atrauma Cardiovascular Forceps)	117
Cooley (Atrauma Tissue Forceps)	118
Cooley (Vascular Dilators)	128

D

Dressing (Scissors)	08
Doyen Abdominal (Scissors)	13
Dissecting Forceps (Serrated Dissecting Forceps)	15
Dissecting Forceps (Delicate Dissecting Forceps)	18
Dissecting Forceps (Toothed Dissecting Forceps)	19
Denis Browne (Splinter Forceps)	22
Doyen Child (Mouth Gags)	27
Doyen Dult (Mouth Gags)	27
Doyen (Towel Clamps)	29
Dunhill (Haemostats Forceps)	37
Derf (Needle Holders)	43
Directors (Probes)	48
Deaver (Hand Held Retractors)	52
Deaver Grip (Hand Held Retractors)	53
Durham (Hand Held Retractors)	56
Doyen (Hand Held Retractors)	59
Doyen (Intestinal Clamps)	67
Doyen Kocher (Intestinal Clamps)	68
Doyen Mayo Robson (Intestinal Clamps)	68,69
Doyen (Vaginal Speculum)	74
Doyen (Ovum Forceps)	80
De Lee (Obstetrics Instruments)	86
Dingman (Bone Holding Forceps)	102
De Vibiss (Bone Cutting Forceps)	108
De-bakey Satinsky (Atrauma Bulldog Clamps)	113
De Bakey-carotis (Atrauma Bulldog Clamps)	113
De Bakey Satinsky (Atrauma Bulldog Clamps)	113
Debakey Bulldog (Atrauma Bulldog Clamps)	113
Debakey Bulldog Clamps (Atrauma Bulldog Clamps)	113
De Bakey-rankin (Atrauma Hemostatic)	114
De Bakey-mosquito (Atrauma Hemostatic)	114
Dietrich (Cardiovascular Forceps)	114
Dale (Atrauma Cardiovascular Forceps)	115
De Bakey (Atrauma Tissue Forceps)	118
De Bakey (Atrauma Cardiovascular Forceps)	120,121,123,124,125
De Bakey (Vascular Dilators)	128
Dissecting Forceps (Monopolar Cables)	131
Derra (Atrauma Cardiovascular Forceps)	127
Dissection Sets (Dissection Instruments)	133,134,135,136

INDEX

E

Ent Complete (Diagnostic Set)	01
Ergonomic (Surgical Handles)	04
Emmet (Serrated Dissecting Forceps)	16
Edna Lorna (Towel Clamps)	29
Elliot (Obstetrics Instruments)	86
Echlin (Bone Rongeurs)	105

F

Favaloro (Scissors)	13
Feilchenfel (Splinter Forceps)	22
Fine Curved Dissecting (Dissecting & Ligature Forceps)	23
Fergusson Acland (Mouth Gags)	27
Featherstone (Mouth Gags)	27
Flat (Tongue Depressors)	28
Forester (Sponge Holding Forceps)	30
Fraser - Adson (Haemostats Forceps)	37
Fraser-kelly (Crile Haemostats Forceps)	37
Fickling Oral (Haemostats Forceps)	41
Fistula Probe (Probes)	49
Farabeuf (Hand Held Retractors)	58
Faure (Peritoneum)	89
Female Catheters (Urology)	93
Frazier (Suction Tubes)	95
Formby (Suction Tubes)	95
Finger Saw (Amputation Instruments)	96
Farabeuf (Bone Levers & Raspatories)	97
Freer Elevator (Bone Levers & Raspatories)	97
Fergusson (Bone Holding Forceps)	100
Finocchietto - Infant (Rib Spreaders)	110
Finocchietto (Rib Spreaders)	110
Finocchietto-baby (Rib Spreaders)	110

G

Gillies (Toothed Dissecting Forceps)	19
Grey Turner (Haemostats Forceps)	34
Gillies (Needle Holders)	45
Gwynne Evans Tonsil (Dissectors)	51
Gosset (Hand Held Retractors)	61
Goligher (Hand Held Retractors)	62
Geary Grant (Cholecystectomy & Gall Stone)	65
Gall Duct Scissors (Cholecystectomy & Gall Stone)	66
Grave (Vaginal Speculum)	72
Galabin (Probes)	76
Green - Armytage Haemostasis Forceps (Dermatology)	88
Gwilliam (Hysterectomy Clamps)	89
Gabriel Rectal Speculum (Proctology)	91
Gillies (Suction Tubes)	94
Gigli Saw With Handle (Bone Rongeurs)	106
Gregory-soft (Atrauma Bulldog Clamps)	113
Glover (Atrauma Cardiovascular Forceps)	119,127
Gregory (Atrauma Cardiovascular Forceps)	115

H

Hegemann's Delicate (Scissors)	10
Heymann Turbinectomy (Delicate Scissors)	11
Hedgeman (scissors)	13
Hunter (Splinter Forceps)	22
Heywood-smith Tongue Forceps (Tongue Depressors)	28
Halstead Mosquito (Haemostats Forceps)	32,33
Heiss (Haemostats Forceps)	40
Heaney (Needle Holders)	45
Hegar (Needle Holders)	46
Halsey (Needle Holders)	46

Hawkin Ambler (Uterine Dilators)	75
Hegar (Uterine Dilators)	75,76
Hegar (Uterine Dilators Complete Sets)	77
Heywood Smith (Ovum Forceps)	79
Heany (Hysterectomy Clamps)	89
Hysterectomy Forceps (Hysterectomy Clamps)	90
Herrick (Urology)	93
House (Suction Tubes)	95
Handle (Suction Tubes)	95
Howarth (Bone Levers & Raspatories)	97
Heath (Mallets)	100
Hey Groves (Bone Holding Forceps)	101
Hartmann (Bone Rongeurs)	103
Heanley (Bone Rongeurs)	104
Handles (Monopolar Handles, Blades, Needle, Turner Warwick Scissors)	132

I

Iris (Delicate Scissors)	11
Irwin (Hand Held Retractors)	62
I.u.d. Removing Hook (Obstetrics Instruments)	86

J

Jefferson (Delicate Dissecting Forceps)	18
Jackson Burrows (Toothed Dissecting Forceps)	21
Jud-allis (Tissue Forceps)	26
Jameson (Needle Holders)	45
Jobson Horne (Probes)	49
Janson Shea (Hand Held Retractors)	64
Jefferson (Hand Held Retractors)	64
Joseph (Bone Levers & Raspatories)	97
Jacobson (Bone Scoops)	99
Jansen-middleton Septum Forceps (Bone Rongeurs)	103
Jansen (Bone Rongeurs)	103
Javid (Atrauma Cardiovascular Forceps)	115
Jeweler Forceps (Bipolar Forceps)	129

K

Kilner (Hcissors)	10
Kelly-crile (Haemostats Forceps)	35
Kelly (Haemostats Forceps)	35
Kelly Halstead (Haemostats Forceps)	35
Kocher (Haemostats Forceps)	35,36
Kilner (Needle Holders)	44
Kings College Hospital Cocainising Wire (Probes)	49
Kocher Thyroid (Dissectors)	50
Kocher Thyroid (Dissectors)	50
King (Dissectors)	50
Kelly (hand Held Retractors)	55
Kocher (Hand Held Retractors)	56,57,58
Kocher Bone Hook (Hand Held Retractors)	60
Kirschner Retractor Set (Hand Held Retractors)	61
Kirschner Retractor Frame (Hand Held Retractors)	61
Kirschner Retractor Blades (Hand Held Retractors)	61
Kocher (Intestinal Clamps)	68
Kristelle (Vaginal Speculum)	73
Kogan Endocervical (Vaginal Speculum)	74
Kevorkian (Cervical Biopsy Forceps)	82
Kielland (Obstetrics Instruments)	86
Kelly Proctoscope (Proctology)	91
Kidney Clamp (Urology)	92
Kelsey Fry (mallets)	100
Killearn (Bone Rongeurs)	105

INDEX

L

Lloyd Davis Rectal (Scissors)	09
Lister Bandage (Scissors)	14
Lane (Delicate Dissecting Forceps)	18
Ligature Forceps (Dissecting & Ligature Forceps)	23
Lawrence (Dissecting & Ligature Forceps)	24
Long Curved (Dissecting & Ligature Forceps)	24
Lane (Tissue Forceps)	25
Lack Tongue Depressor (Tongue Depressors)	28
Lister - Sinus (Dressing Forceps)	31
Lloyd Davis (Haemostats Forceps)	36
Lawrance (Needle Holders)	47
Liebrich Lachrymal (Probes)	49
Logan Turner (Probes)	49
Littauer (Suture Instruments)	51
Littauer Spencer (Suture Instruments)	51
Liver Retractors (Hand Held Retractors)	55
Langenbeck (Hand Held Retractors)	57
Lahey (Cholecystectomy & Gall Stone)	65
Lower (Cholecystectomy & Gall Stone)	65
Langenbeck Bone Hook (Hand Held Retractors)	60
Lane (Intestinal Clamps)	69
Lang Stevenson (Intestinal Clamps)	70
Lane Twin Anastomosis (Intestinal Clamps)	71
Leech Wilkinson (Cervical Biopsy Forceps)	81
Lempert (Bone Scoops)	99
Lucae (Mallets)	100
Lane (Bone Holding Forceps)	101
Lowman (Bone Holding Forceps)	101
Lewin (Bone Holding Forceps)	102
Luer (Bone Rongeurs)	103
Leksell (Bone Rongeurs)	104
Luer-jansen (Bone Rongeurs)	105
Liston Tudor Edwards (Bone Cutting Forceps)	108
Lovelace (Tissue & Organ)	112
Leland Jones (Atrauma Cardiovascular Forceps)	121
Lambert - Kay (Atrauma Cardiovascular Forceps)	125

M

Miller (Laryngoscope Set)	02
Magill (Catheter Forceps)	03
Mcintosh (Laryngoscope Set)	03
Mayo (Scissors)	06
Mayo Harrington (Scissors)	07
Mayo Stille (Scissors)	07
Metzenbaum (Scissors)	08
Mcindoe Scissors (Scissors)	14
Maingot Intestinal (Serrated Dissecting Forceps)	16
Macindoe (Delicate Dissecting Forceps)	17
Micindoe (Toothed Dissecting Forceps)	19
Mustarde (Toothed Dissecting Forceps)	21
Micro Soft Touch Ring Tip (Splinter Forceps)	22
Micro Adson (Dissecting & Ligature Forceps)	23
Mixer (Dissecting & Ligature Forceps)	24
Mayo (Towel Clamps)	29
Moynihan (Towel Clamps)	29
Mayo (Haemostats Forceps)	36
Moynihan (Haemostats Forceps)	40
Mixer (Haemostats Forceps)	40
Mayo Dunhill (Needle Holders)	43
Mayo (Needle Holders)	43,44
Morris (Hand Held Retractors)	54
Moynihan (Hand Held Retractors)	56
Mayo (Needle Holders)	46,47
Mayo Baumgartner (Needle Holders)	46
Mayo Masson (Needle Holders)	46
Mathieu (Needle Holders)	46

Mathieu (Needle Holders)	47
Mcphails (Needle Holders)	47
Macdonald (Dissectors)	50
Middeldorpf (Hand Held Retractors)	56
Mixer (Cholecystectomy & Gall Stone)	65
Mills (Cholecystectomy & Gall Stone)	66
Moynihan (Cholecystectomy & Gall Stone)	66
Mouat Gall Bladder Lifting Forceps (Cholecystectomy & Gall Stone)	66
Mcgee Lateral Viginal Retractor (Vaginal Speculum)	72
Mathieu (Vaginal Speculum)	74
Modified Wertheim (Vaginal Speculum)	74
Martin (Probes)	76
McIntock (Ovum Forceps)	79
Mikulicz (Peritoneum)	89
Maingot (Hysterectomy Clamps)	90
Mcevedy Rectal Speculum (Proctology)	91
Millin (Urology)	92
Macdonald (Bone Levers & Raspatories)	97
Martini (Bone Scoops)	99
Macewen (Bone Scoops)	99
Mead (Bone Rongeurs)	103
Martin (Atrauma Cardiovascular Forceps)	116
Measuring (Vascular Measuring Device)	117
Morris De Bakey (Atrauma Cardiovascular Forceps)	125
Mcpherson (Bipolar Forceps)	129
Monopolar Cables (Monopolar Cables)	131
Mcindoe (Monopolar Cables)	131

N

Nelson Lung Adhesion (Toothed Dissecting Forceps)	21
Negus Tonsil (Tonsil Artery Forceps)	42
Naunton Morga (Needle Holders)	44
Norfolk And Norwich (Hand Held Retractors)	63
Noto (Ovum Forceps)	79
Naegele (Obstetrics Instruments)	86
Naunton Morgan Sims Rectal Speculum (Proctology)	91
Northfield (Bone Rongeurs)	104,105
Needle	132
(Monopolar Handles, Blades, Needle, Turner Warwick Scissors)	

O

Otoscope Set	01
Officer (Toothed Dissecting Forceps)	21
O'shaughnessy (Haemostats Forceps)	41
Olsen Hegar (Needle Holders)	45
Olivecrona (Bone Rongeurs)	106
Ochsner (Cardiovascular Forceps)	114

P

Potts (Scissors)	13
Pennybacker (Delicate Dissecting Forceps)	18
Probe With Eye (Probes)	48
Payr (Dissectors)	51
Potts-de Martel (Cholecystectomy & Gall Stone)	66
Parker Kerr (Intestinal Clamps)	70
Payr (Intestinal Clamps)	70
Pederson (Vaginal Speculum)	72
Perotoneum (Peritoneum)	89
Phaneuf (Hysterectomy Clamps)	90
Pratt Rectal Speculum (Proctology)	91
Poole (Suction Tubes)	94
Percy Amputation Flap Retractor (Amputation Instruments)	96

INDEX

Pennybacker (Bone Levers & Raspatories)	98
Pennybacker (Bone Rongeurs)	104
Plaster Shears (Plaster Cast Removal Instruments)	109
Price-thomas (Bronchus)	112
Potts (Atrauma Cardiovascular Forceps)	119,120
Patient Care Items (Patient Care Items)	137
Patient Treatment Items (Patient Treatment Items)	138

R

Reynolds (Scissors)	14
Ramsey (Serrated Dissecting Forceps)	16
Ramsey (Toothed Dissecting Forceps)	20
Russian (Toothed Dissecting Forceps)	21
Rutherford Morison (Tissue Forceps)	25
Robin (Towel Clamps)	29
Ramley (Sponge Holding Forceps)	30
Rochester - Oschner (Haemostats Forceps)	36,37
Rochster Pean (Haemostats Forceps)	39
Roberts (Haemostats Forceps)	40
Richardson (Hand Held Retractors)	54
Retractor (Hand Held Retractors)	60
Ricard (Hand Held Retractors)	61
Rntne Hospital (Hand Held Retractors)	63
Recamier (Uterine Cannulae)	85
Randall (Urology)	92
Ruskin (Bone Rongeurs) 1	103
Rudor Edwards Costotome (Bone Rongeurs)	106
Ruskin - Liston (Bone Cutting Forceps)	108
Riches Forceps (Monopolar Cables)	131

S

Surgical Handles (Standard)	04,05
Strabismus (Delicate Scissors)	11
Stevens Tenotomy (Delicate Scissors)	12
Schuknecht Wire Cutting (Oral Scissors)	12
Schumacher Umbilical (Scissors)	14
St Marks (Serrated Dissecting Forceps)	16
St Marks (Toothed Dissecting Forceps)	21
S-shaped Delicate (Dissecting & Ligature Forceps)	23
Stiles Allis-Thoms (Tissue Forceps)	25
Spencer Wells (Haemostats Forceps)	38
Schmidt Tonsil (Tonsil Artery Forceps)	42
Sinus (Probes)	48
Simon (Hand Held Retractors)	59
Seton Pringle Bainbridge (Intestinal Clamps)	69
Schoemaker (Intestinal Clamps)	70
Sims (Vaginal Speculum)	73
Sims (Probes)	76
Schroeder (Tenaculum Forceps)	78
Schubert (Cervical Biopsy Forceps)	81
Schumarcher (Cervical Biopsy Forceps)	82
Simon (Uterine Scoops And Curettes)	83
Sims (Uterine Scoops And Curettes)	83
Sims (Uterine Curettes)	84
Sims (Uterine Cannulae)	85
Simpson (Obstetrics Instruments)	86
Simpson-Braun (Obstetrics Instruments)	86
Saenger Ovum Forceps (Gynecology Instruments)	88
Sims Rectal Speculum (Proctology)	91
Suction Tubes (Suction Tubes)	95
Spare Disks (Mallets)	100
Sequestum (Bone Holding Forceps)	100
Semb (Bone Holding Forceps)	102
Synovectomy Rongeur (Bone Rongeurs)	104
Sargent Van Havre (Bone Rongeurs)	106

Stille-ruskin (Bone Rongeurs)	106
Stille Liston (Bone Cutting Forceps)	108
Semb (Ligature Carriers)	112
Scalple Handle (Monopolar Handles,Blades,Needle,Turner Warwick Scissors)	132

T

Treves (Delicate Dissecting Forceps)	18
Troeltsch Wilde (Splinter Forceps)	22
Tudichum (Splinter Forceps)	22
Tubing Clamp (Haemostats Forceps)	41
Travers (Hand Held Retractors)	62
Tischler-morgan (Cervical Biopsy Forceps)	82
Tinckler Simpson Smith (Suction Tubes)	94
Trotter (Bone Rongeurs)	104
Treatment Room Items (Treatment Room Items)	139,141

U

Uterine (Scissors)	09
Umbilical Dilator (Gynecology Instruments)	88

V

Volkman (Bone Levers & Raspatories)	98
Volkman (Bone Scoops)	99
Verbrugge (Bone Holding Forceps)	102

W

Woods Tonsil (Oral Scissors)	12
Wheeler Tonsil (Oral Scissors)	12
Wilson Tonsil (Oral Scissors)	12
Waugh (Delicate Dissecting Forceps)	17,18
Wilson Tonsil (Tonsil Artery Forceps)	42
Wangensteen (Needle Holders)	44
Wright (Needle Holders)	45
Ward (Needle Holders)	45
Webster (Needle Holders)	47
Watson Cheyne (Dissectors)	50
Walton (Hand Held Retractors)	58
Weislander (Hand Held Retractors)	63
Weislander (Hand Held Retractors)	63,64
Wilson (Tenaculum Forceps)	78
Wittner (Cervical Biopsy Forceps)	82
Wrigley (Obstetrics Instruments)	86
Winter Ovum Forceps (Gynecology Instruments)	88
Williger (Bone Levers & Raspatories)	97
Wilms (Bone Rongeurs)	104
Ward (Bone Cutting Forceps)	108
Wilson Hey Forceps (Monopolar Cables)	131

Y

Yankauer (Suction Tubes)	94
---------------------------------	----

Z

Zaufal-Jansen (Bone Rongeurs)	105
--------------------------------------	-----

*High Quality
Instruments*

Diagnostic
Laryngoscope
Scissors
Dissecting
Hamostats Forceps
Needle Holders
Retractors
Cordio Vascular
Electro Surgical
Hollow Ware



SURGICAL
INSTRUMENTS

